

FOOD SERVICE EQUIPMENT

GASTRONOMIE- UND SERVIERARTIKEL

GEREEDSCHAP VOOR CHEFS

EQUIPEMENT DE CUISINE

SINCE 2008

2021



c a t e r i n g

It is our great pleasure to present you Eagle's catalogue of food service equipment. With many items introduced in this catalogue, we are sure that our comprehensive range of products can help you explore more markets & customers.



c a t e r i n g

**STORAGE &
TRANSPORT**



Serving Trolleys



- Made of stainless steel
- Flatpack delivery
- Easy to assemble



Multipurpose Service Trolley 2 Tier

Item No.	mm
PRC-L2	860x540x(H)940
PRC-M2	810x460x(H)850
PRC-S2	710x410x(H)810



Multipurpose Service Trolley 3 Tier

Item No.	mm
PRC-L3	860x540x(H)940
PRC-M3	810x460x(H)850
PRC-S3	710x410x(H)810



Polypropylene Trolleys

- Color Options: Gray or Black

Item No.	mm
PST-80	830x420x(H)970
PST-100	1070x500x(H)990
PST-01 Waste Container	330x230x(H)560, 30L
PST-02 Cutlery Container	330x230x(H)175, 9L



Tote Box

Item No.	mm
TOTB01	525x380x(H)150



Service Trolley with Rails

Item No.	mm
PRR-L2	860x540x(H)940
PRR-M2	810x460x(H)850
PRR-S2	710x410x(H)810



Trolley with deep clearing basin

Item No.	mm
PRB-L3	860x540x(H)940



Multipurpose Service Trolley 4 Tier

Item No.	mm
PRC-L4	860x540x(H)1250

Multipurpose Service Trolley 5 Tier

Item No.	mm
PRC-L5	860x540x(H)1550

Serving Trolleys



- Made of stainless steel
- Flatpack delivery
- Easy to assemble



Square Tube Service Trolley 2 Tier

Item No.	mm
PRD-L2	950x500x(H)950
PRD-M2	850x460x(H)900
PRD-S2	750x400x(H)835



Square Tube Service Trolley 3 Tier

Item No.	mm
PRD-L3	950x500x(H)950
PRD-M3	850x450x(H)900
PRD-S3	750x400x(H)835



Polypropylene Trolleys

- Color Options: Gray or Black
- Triangle Pipe

Item No.	mm
PSD-80	845x430x(H)950
PSD-100	1020x500x(H)960



Trolley with doors

Item No.	mm
PSD-100D	1020x500x(H)960

Rack Trolleys



Whether it transport, temporary or long-term storage will make any chef happy. It ideally suited for storing and transporting GN containers, bakery pans, serving salads and desserts.



Rack Trolley with Work Top

RT11T 380x550xH1000
entry 325 mm, 7Layer

RT21T 590x670xH1000
entry 530 mm
7Layer

RT40T 470x620xH1000
entry 400 mm, 8Layer

Slider Option:



Rack Trolley 15/18 Layer For GN Pan

RT1115 380x550xH1735
entry 325 mm

RT1118 380x550xH1765
entry 530 mm
with Mid-Tubes

RT2115 590x670xH1735
entry 530 mm

Slider Option:

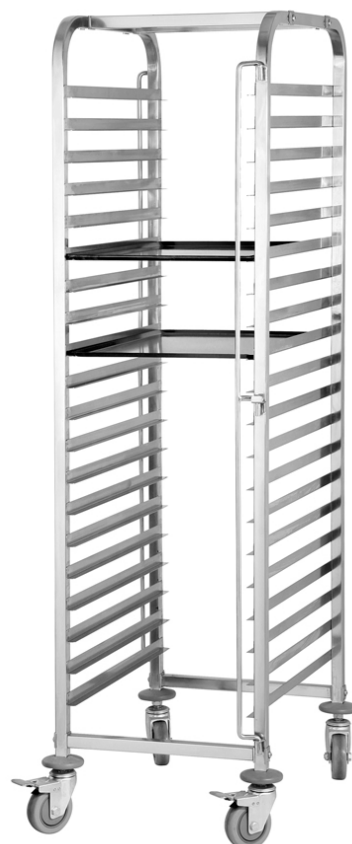

Rack Trolley 15/20 Layer For 40 x 60 cm

RT4015 470x620xH1735
entry 400 mm

RT4020 470x620xH1765
entry 400 mm
with Mid-Tubes

RT6015 670x820xH1735
entry 600 mm

Slider Option:



**Accept
customized**



Baking Pan

Item No.	mm
BT-63	400x600x10, Aluminum
BT-64	400x600x10, Stainless
BT-65	400x600x20, Aluminum

PS: Perforated is available.



Rack Trolley for Dishwasher Basket

Item No.	mm
DWR-4	555x505xH1000, 4 Layers
DWR-7	555x505xH1700, 7 Layers



Nestable Rack Trolley 15 / 18 / 20 Layer

Ref.	Size (mm)		Description
NRT1115	380 x 550 x H1600	85mm	15 levels GN1/1
NRT2115	590 x 670 x H1600	85mm	15 levels GN2/1
NRT1118	380 x 550 x H1700	75mm	18 levels GN1/1
NRT2118	590 x 670 x H1700	75mm	18 levels GN2/1
NRT1120	380 x 550 x H1735	70mm	20 levels GN1/1
NRT2120	590 x 670 x H1735	70mm	20 levels GN2/1
NRT4020	470 x 620 x H1735	70mm	20 levels 40x60cm

PS: Assembled or welding

provide customized service.



Platform Carts (Foldable)

Item No.	mm
CART-7SF	740 x 480 x H870



Thermobox Carts (Foldable)

Item No.	mm
CART-7PF	730 x 480 x H825



Platform Carts Round edge

Item No.	mm
CART-90	900 x 550 x H870
CART-100	1000 x 600 x H870



Stockpot Dolly Stainless Steel

Item No.	mm
CART-42	Dia.420x(H)130
CART-47	Dia.470x(H)130
CART-52	Dia.520x(H)130
CART-57	Dia.570x(H)130
CART-62	Dia.620x(H)130





Mobile Plate Trolley

Item No.	mm
RT6560	650x600xH1920, for 84 plates



OPTION:
WITH TAP

Thermo-Insulated Container

Item No.	Liter	mm(inner)
IPC12W	12L	Φ250x(H)250
IPC22W	22L	Φ300x(H)300
IPC35W	35L	Φ350x(H)350
IPC50W	50L	Φ400x(H)400
IPC70W	70L	Φ450x(H)450
IPC100W	100L	Φ500x(H)500
IPC130W	130L	Φ550x(H)550



OPTION:
WITH TAP

Thermo-Insulated Container

Item No.	Liter	mm(inner)
IPC12X	12L	Φ250x(H)250
IPC22X	22L	Φ300x(H)300
IPC35X	35L	Φ350x(H)350
IPC50X	50L	Φ400x(H)400
IPC70X	70L	Φ450x(H)450
IPC100X	100L	Φ500x(H)500
IPC130X	130L	Φ550x(H)550

Waste Bag Holder



Item No.	mm
WBT-130L	420×580×H960



Mobile Waste Bin

Item No.	mm
WBT-50L	Dia 350 mm x H 600,50L
WBT-100L	Dia 480 mm x H 700,100L
WBT-50P	Dia 350 mm x H 600,50L with pedal
WBT-100P	Dia 480 mm x H 700,100L with pedal



Pedal

Plate Dispenser Trolley



Item No.	mm
PL9850	980 × 515 x H800





Cutlery Trolley with dishes

Item No.	mm
CCT-L3	630x400xH940 Including 2 pcs dishes



Cutlery Trolley for 4 pcs GN pan

Item No.	mm
CCT-L2	810 × 570 × H1065 without GN pans



2 Tiers Serving Trolley Heavy Duty

Item No.	mm
PRO-86	800 × 600 × H850
PRO-95	900 × 500 × H850
PRO-105	1000 × 500 × H850
PRO-116	1100 × 600 × H850
PRO-126	1200 × 600 × H850

PS: All welding



3 Tiers Serving Trolley Heavy Duty

Item No.	mm
PRP-86	800 × 600 × H850
PRP-95	900 × 500 × H850
PRP-105	1000 × 500 × H850
PRP-116	1100 × 600 × H850
PRP-126	1200 × 600 × H850

PS: All welding

Insulated food Container

- Stainless steel
- With 3 latches and folding handles
- Lid with seal

Item No.	mm	Capacity (liter)
IB1818	Φ180x(H)180	4
IB2020	Φ200x(H)200	6
IB2222	Φ220x(H)220	8
IB2525	Φ250x(H)250	12
IB3030	Φ300x(H)300	25
IB3535	Φ350x(H)350	35
IB4040	Φ400x(H)400	50
IB4048	Φ400x(H)480	60
IB4545	Φ450x(H)450	70
IB4550	Φ450x(H)500	80
IB5050	Φ500x(H)500	100
IB5060	Φ500x(H)600	120



Insulated Beverage Dispenser

- Stainless steel
- With 3 latches and folding handles
- Lid with seal

Item No.	mm	Capacity (liter)
IBT1818	Φ180x(H)180	4
IBT2020	Φ200x(H)200	6
IBT2222	Φ220x(H)220	8
IBT2525	Φ250x(H)250	12
IBT3030	Φ300x(H)300	25
IBT3535	Φ350x(H)350	35
IBT4040	Φ400x(H)400	50
IBT4048	Φ400x(H)480	60
IBT4545	Φ450x(H)450	70
IBT4550	Φ450x(H)500	80
IBT5050	Φ500x(H)500	100
IBT5060	Φ500x(H)600	120



TCC06



TCC-T

Thermo Catering Container & Trolley

Item No.	mm
TCC-01	477 × 680 × H620, suitable for 6*GN1/1x65mm, 4*GN1/1x100mm, 3*GN1/1x150mm, 2*GN1/1x200mm.
TCC-T	530 × 710 × H230



Thermo Catering Container

Item No.	mm
TCC-02	630 × 440 × H260 For 1*GN1/1x150mm
TCC-03	630 × 440 × H305 For 1*GN1/1x200mm



Thermo Catering Dispenser

Item No.	mm
TCC-04	420 × 230 × H470, 9.6L
TCC-05	420 × 230 × H620, 18L

Insulated Ice Container

Item No.	mm
TCC-06	585 × 800 × H745, 110L



Plate Catering Trolley

Item No.	mm
TCC-07	930 × 720 × H800 can hold 4.5" to 13" plates 6 stacks, total 300pcs, 6 dividers



Ingredient Trolley

Item No.	mm
TCC-08	394 × 755 × H735, 102L
TCC-09	333 × 743 × H711, 81L





c a t e r i n g

TABLE SHELVES



Work tables - Depth 700 mm

Stainless steel, Scotch-Brite polish, 40 mm bevelled edges
Legs made of a square pipe 40 x 40 mm
and adjustable to 50 mm

Height 850-900 mm

Table is delivered one-piece ready-welded.

Work Table w/o Splashback with bottom shelf

W (mm)	D (mm)	Code No.
800	700	306 087
1000	700	306 107
1200	700	306 127
1400	700	306 147
1600	700	306 167
1800	700	306 187
2100	700	306 217
2400	700	306 247



Drawers for work tables series 700

1/1 GN, 65 mm deep, for on-site mounting

Drawer
1 x 1/1 GN
Weight: 9 kg
Code No.: DR7011

Drawer
3 x 1/1 GN
Weight: 23.5kg
Code No.: DR7031



Work Table with Splashback with bottom shelf

W (mm)	D (mm)	Code No.
800	700	316 087
1000	700	316 107
1200	700	316 127
1400	700	316 147
1600	700	316 167
1800	700	316 187
2100	700	316 217
2400	700	316 247



Work tables - Depth 600 mm

Stainless steel, Scotch-Brite polish, 40 mm bevelled edges
Legs made of a square pipe 40 x 40 mm
and adjustable to 50 mm

Height 850-900 mm

Table is delivered one-piece ready-welded.

Work Table without Splashback with bottom shelf



W (mm)	D (mm)	Code No.
800	600	306 086
1000	600	306 106
1200	600	306 126
1400	600	306 146
1600	600	306 166
1800	600	306 186
2100	600	306 216
2400	600	306 246



Drawers for work tables series 600

1/1 GN, 65 mm deep, for on-site mounting

Drawer
1 x 1/1 GN
Weight: 9 kg
Code No.: DR6011

Drawer
3 x 1/1 GN
Weight: 23.5kg
Code No.: DR6031

Work Table with Splashback with bottom shelf



W (mm)	D (mm)	Code No.
800	600	316 086
1000	600	316 106
1200	600	316 126
1400	600	316 146
1600	600	316 166
1800	600	316 186
2100	600	316 216
2400	600	316 246

Work Table without Splashback with bottom shelf

W (mm)	D (mm)	Code No.
800	700	406 087
1000	700	406 107
1200	700	406 127
1400	700	406 147
1600	700	406 167
1800	700	406 187
2100	700	406 217
2400	700	406 247



Work Table with Splashback with bottom shelf

W (mm)	D (mm)	Code No.
800	700	416 087
1000	700	416 107
1200	700	416 127
1400	700	416 147
1600	700	416 167
1800	700	416 187
2100	700	416 217
2400	700	416 247





Work Table without Splashback with bottom shelf

W (mm)	D (mm)	Code No.
800	600	406 086
1000	600	406 106
1200	600	406 126
1400	600	406 146
1600	600	406 166
1800	600	406 186
2100	600	406 216
2400	600	406 246



Work Table with Splashback with bottom shelf

W (mm)	D (mm)	Code No.
800	600	416 086
1000	600	416 106
1200	600	416 126
1400	600	416 146
1600	600	416 166
1800	600	416 186
2100	600	416 216
2400	600	416 246

Work Table without Splashback with open base

W (mm)	D (mm)	Code No.
800	700	506 087
1000	700	506 107
1200	700	506 127
1400	700	506 147
1600	700	506 167
1800	700	506 187
2100	700	506 217
2400	700	506 247



Work Table with Splashback with open base

W (mm)	D (mm)	Code No.
800	700	516 087
1000	700	516 107
1200	700	516 127
1400	700	516 147
1600	700	516 167
1800	700	516 187
2100	700	516 217
2400	700	516 247





Work Table without Splashback with open base

W (mm)	D (mm)	Code No.
800	600	506 086
1000	600	506 106
1200	600	506 126
1400	600	506 146
1600	600	506 166
1800	600	506 186
2100	600	506 216
2400	600	506 246



Work Table with Splashback with open base

W (mm)	D (mm)	Code No.
800	600	516 086
1000	600	516 106
1200	600	516 126
1400	600	516 146
1600	600	516 166
1800	600	516 186
2100	600	516 216
2400	600	516 246

Wall cabinets, open

Stainless steel, Scotch-Brite polish
Intermediate shelf, height-adjustable
Depth 400 mm, height 660 mm

W (mm)	D (mm)	Code No.
1000	400	308 104
1200	400	308 124
1400	400	308 144
1600	400	308 164
1800	400	308 184



Wall cabinets with sliding doors

Stainless steel, Scotch-Brite polish
Intermediate shelf, height-adjustable
Sound-proofed sliding doors
Depth 400 mm, height 660 mm

W (mm)	D (mm)	Code No.
1000	400	318 104
1200	400	318 124
1400	400	318 144
1600	400	318 164
1800	400	318 184



Cupboard with 3 intermediate shelves

Stainless steel,
Legs made of square-pipe, 40 x 40 mm and adjustable to 65 mm
Shelves bevelled by 40 mm on all sides and reinforced with cross bar
Height 2000 mm

with double doors

W (mm)	D (mm)	Code No.
800	600	309 086
1000	700	309 107

with 2 sliding doors

W (mm)	D (mm)	Code No.
1200	600	309 126
1400	600	309 146
1600	600	309 166
1400	700	309 147
1600	700	309 167



✓ Customized designs deliverable on request,
list price is according to the next higher
standard size.

Cupboards

with sliding doors and intermediate shelf

Stainless steel, Scotch-Brite polish, 40 mm bevelled edges with sliding doors

Intermediate shelf height adjustable

Legs made of square-pipe 40 x 40 mm and adjustable to 50 mm

Height 850-900 mm, 40 mm splashback



Cupboard without splashback Depth 700 mm

W (mm)	D (mm)	Code No.
1000	700	508 107
1200	700	508 127
1500	700	508 157
1800	700	508 187
2000	700	508 207

Heated cupboards

with sliding doors and intermediate shelf

Stainless steel, Scotch-Brite polish, 40 mm bevelled edges with sliding doors

Legs made of square-pipe 40 x 40 mm and adjustable to 50 mm

Power: 2 kW / 230 V 50/60 Hz

Height 850-900 mm, 40 mm splashback



Heated cupboard without splashback Depth 700 mm

W (mm)	D (mm)	Code No.
1000	700	509 107
1200	700	509 127
1500	700	509 157
1800	700	509 187
2000	700	509 207

Wall Shelf 1 Layer (L support)

Dimension (mm)	Item No. w/ L supports
1000x300x(H)60, 2 supports	WS100
1200x300x(H)60, 2 supports	WS120
1400x300x(H)60, 2 supports	WS140
1600x300x(H)60, 2 supports	WS160
1800x300x(H)60, 3 supports	WS180
2000x300x(H)60, 3 supports	WS200
2200x300x(H)60, 3 supports	WS220



Plate Shelf

W(mm)	D(mm)	Code No.
800	200	PWS082
1000	200	PWS102
1200	200	PWS122
1400	200	PWS142
800	300	PWS083
1000	300	PWS103
1200	300	PWS123
1400	300	PWS143



Spice shelves

- for 1/6 GN containers
- made of stainless steel
- with GN container stopper, fastener included

W(mm)	D(mm)	QTY	Code No.
800	200	4 x 1/6 GN	SWS082
1000	200	5 x 1/6 GN	SWS102
1200	200	6 x 1/6 GN	SWS122
1400	200	7 x 1/6 GN	SWS142





Work table 2 Tiers

Reinforced working top in stainless steel, up to approx. 250 kg carrying capacity. Shelf made of special coated steel with adjustable board, approx. 150 kg maximum load, height adjustable feet.

Easy assembly.

Size: W 1200 x D 600 x H 880-900 mm

Weight: 17,2 kg

Code No.: 300 126



Work table 3 Tiers

Reinforced working top in stainless steel, up to approx. 250 kg carrying capacity. Shelf made of special coated steel with 2 adjustable boards, each approx. 150 kg maximum load per board, height adjustable feet. Easy assembly.

Size: W 1300 x D 690 x H 880-900 mm

Weight: 24,6 kg

Code No.: 300 137



Wine rack

Chrome-plated

For approx. 100 - 130 bottles

5 grid shelves, 4 poles

9 recesses for bottles per board

Easy assembly

Size: W 900 x D 350 x H 1390 mm

Weight: 12,5 kg

Code No.: 310 903

Office-Shelf

Chrome-plated
 4 grid shelves, 4 poles
 Carrying capacity 150 kg, load evenly distributed
 Easy assembly
 Size: W 750 x D 350 x H 1520 mm
 Weight: 10,3 kg
Code-No.: 310 083



Store-Shelf

Chrome-plated
 4 grid shelves, 4 poles
 Carrying capacity 200 kg,
 load evenly distributed
 Easy assembly
 Size: W 910 x D 460 x H 1845 mm
 Weight: 14,3 kg
Code-No.: 310 095

Store-Shelf Heavy Style

Steel, chrome-plated
 4 shelves, height-adjustable
 Shelf size: W 1210 x D 610 mm
 Load-bearing capacity, max.:
 500 kg in total, 125 kg per shelf
 Size: W 1210 x D 610 x H 1840 mm
 Weight: 25,6 kg
Code-No.: 310 126

Chrome-Plated Wire Shelving Units

- Adjustable shelves, max shelf load 200kg
- Shelves and poles sold in a set of 4 pcs
- for warehouse and shop usage

D(mm)	D(mm)	Product	Item No.
610	455	SHELF	320061
910	455	SHELF	320091
1220	455	SHELF	320121
1525	455	SHELF	320151
610	610	SHELF	321061
910	610	SHELF	321091
1060	610	SHELF	321101
1220	610	SHELF	321121
1525	610	SHELF	321151
1825	610	SHELF	321181
	H=18000MM, POLE		322001



Wall Shelf 2 Tiers (Adjustable)

Dimension (mm)	Item No. w/ splashback
1000x355x(H)60	WS100A
1200x355x(H)60	WS120A
1400x355x(H)60	WS140A
1600x355x(H)60	WS160A
1800x355x(H)60	WS180A
2000x355x(H)60	WS200A
2200x355x(H)60	WS220A





Sink centre with 1 basin and drip off surface

Item Size (mm)	Basin Size (mm)	Code No.
1200x600xH850	400x400xH250,left	711 126
1200x600xH850	400x400xH250,right	721 126
1200x700xH850	500x500xH250,left	711 127
1200x700xH850	500x500xH250,right	721 127



Delivery without dishwasher

Sink with 2 basin and drip off surface

Item Size (mm)	Basin Size (mm)	Code No.
1400x700xH850	400x500xH250,left	712 147
1400x700xH850	400x500xH250,right	722 147
1600x700xH850	500x500xH250,left	712 167
1600x700xH850	500x500xH250,right	722 167



Sink with 2 basin and drip off surface

Item Size (mm)	Basin Size (mm)	Code No.
1800x600xH850	400x400xH250,left	712 186
1800x600xH850	400x400xH250,right	722 186
1800x700xH850	500x500xH250,left	712 187
1800x700xH850	500x500xH250,right	722 187
2100x600xH850	400x400xH250,left	712 216
2100x600xH850	400x400xH250,right	722 216
2100x700xH850	500x500xH250,left	712 217
2100x700xH850	500x500xH250,right	722 217

Sinks - construction

made of stainless steel, Scotch-Brite grinding, 40 mm bevelled edges, legs made of a square pipe 40 x 40 mm and adjustable to 50 mm, with basin panelling, 40 mm splashback.



Sink with 1 basin

Item Size (mm)	Basin Size (mm)	Code No.
600x600xH850	400x400xH250	901 066
800x700xH850	500x500xH250	901 087

Sink with 1 basin and drip off surface

Item Size (mm)	Basin Size (mm)	Code No.
1000x600xH850	400x400xH250, left	911 106
1000x600xH850	400x400xH250, right	921 106
1200x600xH850	400x400xH250, left	911 126
1200x600xH850	400x400xH250, right	921 126
1200x700xH850	500x500xH250, left	911 127
1200x700xH850	500x500xH250, right	921 127
1400x700xH850	500x500xH250, left	911 147
1400x700xH850	500x500xH250, right	921 147



Sink with 2 basin and drip off surface

Item Size (mm)	Basin Size (mm)	Code No.
1600x700xH850	500x500xH250, left	912 167
1600x700xH850	500x500xH250, right	922 167
1800x600xH850	400x400xH250, left	912 186
1800x600xH850	400x400xH250, right	922 186
1800x700xH850	500x500xH250, left	912 187
1800x700xH850	500x500xH250, right	922 187



✓ Sinks and sink centres are also available with a construction depth of 600 mm.



c a t e r i n g

HOTEL ARTICLE



Laundry Cart

#803 101

- Dia.25mm stainless steel tube in polished finish
- 4 swivel castors Dia.75mm, 2 with locking device
- Size: 900 x 540 x (H)920 mm



#803 102

- Dia.25mm chrome nickel steel tube in polished finish
- 4 swivel castors Dia.75mm, 2 with locking device
- Size: Dia.600 x (H)800 mm



#803 103

- Dia.25mm chrome nickel steel tube in polished finish
- 4 swivel castors Dia.100mm, 2 with locking device
- Size: 600 x 610 x (H)1000 mm



#803 104

- Dia.25mm chrome nickel steel tube in polished finish
- 4 swivel castors Dia.100mm, 2 with locking device
- Size: 950 x 580 x (H)840 mm





Luggage Rack

#803 201

- Dia.25mm stainless steel tube in polished finish
- With wall protection and black nylon straps, collapsible
- Size: 550 x 500 x (H)700 mm



#803 202

- Dia.25mm stainless steel tube in polished finish
- With black nylon straps, collapsible
- Size: 520 x 410 x (H)800 mm



#803 203

- Made of solid wood
- With black nylon straps, collapsible
- Size: 610 x 440 x (H)550 mm



#803 204

- Made of solid wood
- With wall protection and black nylon straps, collapsible
- Size: 600 x 445 x (H)670 mm

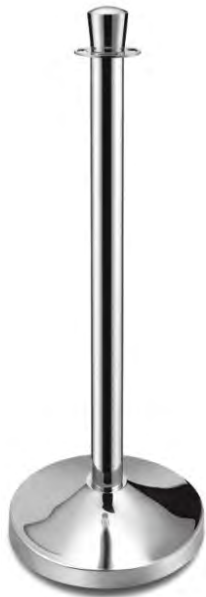

#221 181



#221 182

HOT

Crown Barrier Post

Base (mm)	Tube (mm)	Height (mm)
Φ320	Φ51	1000

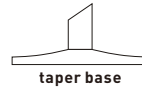

Option:
 Polished finish - (#221 181)
 Golden finish - (#221 182)

Poly Rope

Φ32 x (L)1500mm

Option:
 Head: polished or gold
 Length: 1.5m, 2.0m and 2.5m



#220



#221



Wall rope hook
 Silver - (#111 199)
 Golden - (#111 299)

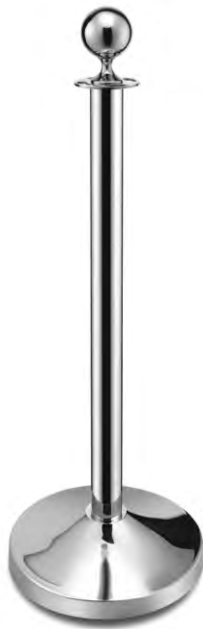

#111 131



#111 132

HOT

Ball Barrier Post

Base (mm)	Tube (mm)	Height (mm)
Φ320	Φ51	1000

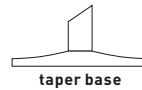

Option:
 Polished finish - (#111 131)
 Golden finish - (#111 132)

Velour Rope

Φ32 x (L)1500mm

Option:
 Head: polished or gold
 Length: 1.5m, 2.0m and 2.5m



#110



#111

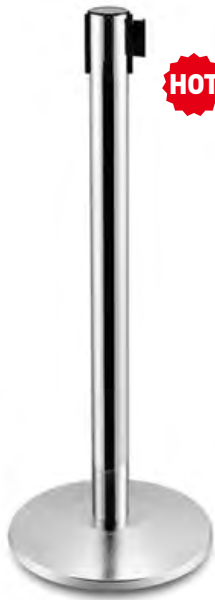

HOT

Belt Barrier Post (2M)

Base (mm)	Tube (mm)	Height (mm)
-----------	-----------	-------------

Φ320 Φ63 950

Polished finish - **(#243 211)**

Option:

Belt length available in: 3m

Base available in: flat / dome

Belt color:



Red Blue Yellow Black Green Gray

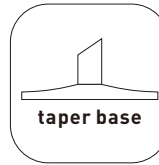

taper base

#241 211

- 320 mm **taper base**

- with 2m retractable belt

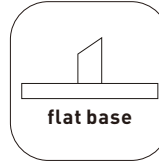

flat base

#242 211

- 320 mm **flat base**

- with 2m retractable belt

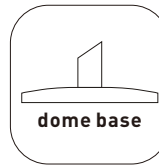

dome base

#243 211

- 320 mm **dome base**

- with 2m retractable belt



HOT

Belt Barrier Post in Black

Base (mm)	Tube (mm)	Height (mm)
-----------	-----------	-------------

Φ320 Φ63 950

Steel in black finish

With **2M** retractable belt - **(#242-212-R)**

With **3M** retractable belt - **(#242-212R3)**

Φ320xΦ76xH910mm

With **5M** retractable belt - **(#243-512)**

Option:

Base available in: flat / dome

Belt color:



Red Blue Yellow Black Green Gray



dome base



Belt Barrier Post

Base (mm)	Tube (mm)	Height (mm)
-----------	-----------	-------------

Φ320 Φ51 950

With 2m retractable belt

Removable head with braking

Polished finish - **(#262 111)**

Golden finish - **(#262 112)**

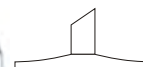

taper base



Stackable Barrier Post

Base (mm)	Tube (mm)	Height (mm)
Φ350	Φ51	980

Polished finish - **(#231 111)**
 Golden finish - **(#231 112)**

Option:
 Cylinder final head
 or belt head with braking



Stackable Barrier Post with wheels

Base (mm)	Tube (mm)	Height (mm)
Φ350	Φ51	880

With 2m retractable belt
 Steel in black finish - **(#251 202)**

Option:
 Belt length available in: 3m
 Belt color:

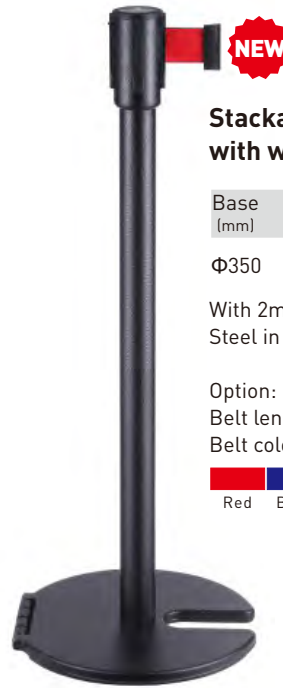

HOT Belt Barrier Post in Aluminum

Base (mm)	Tube (mm)	Height (mm)
Φ350	Φ70	1020

With 2m retractable belt
 Chrome finish - **(#251 102)**

Option:
 Base available in: flat / taper
 Belt color:

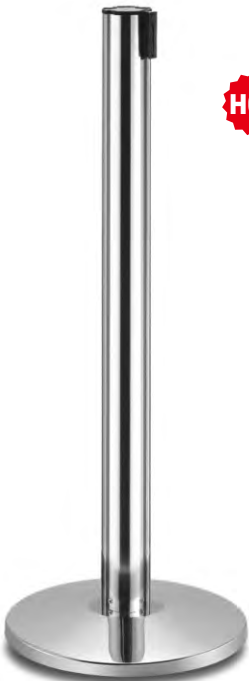

Belt Barrier Post in Aluminum

Base (mm)	Tube (mm)	Height (mm)
Φ350	Φ70	1020

With 2m retractable belt
 Black finish - **(#251 103)**

Option:
 Base available in: flat / taper
 Belt color:

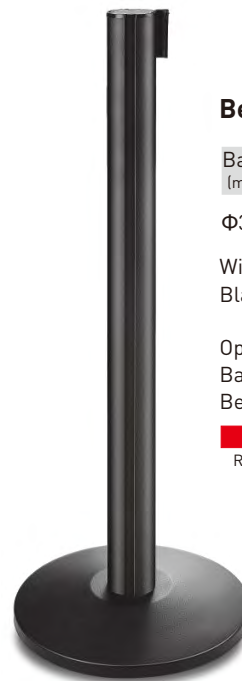



HOT

Ball Barrier Post

Base (mm)	Tube (mm)	Height (mm)
Φ320	Φ51	1000

With black chrome tube
 Polished finish - (#251 302)
 Golden finish - (#251 312)

Option:
 - Cylinder final
 - Base available in: flat / dome



Removable Mount Floor Barrier Post

Hole (mm)	Tube (mm)	Height (mm)
Φ60	Φ63	1000

With 2m retractable belt
 Polished finish - (#251 411)

Option:
 Belt length available in: 3m
 Belt color:



Belt color optional in:



HOT

Double Belt Barrier Post

Base (mm)	Tube (mm)	Height (mm)
Φ350	Φ63	910

With 2m retractable belt
 Polished finish - (#288 111)
 Steel in black finish - (#288 112)

Option:
 Base available in: flat / dome
 Belt color:



Belt Barrier Post

Base (mm)	Tube (mm)	Height (mm)
Φ200	Φ51	1000

- With 2m retractable belt
 - Adhesive mount floor base
 - Glue to floor without destroy
 Polished finish - (#251 511)

Option:
 Belt length available in: 3m
 Belt color:





Banner Stand Set (#261 151) HOT
with 1pc screen & 2pcs posts

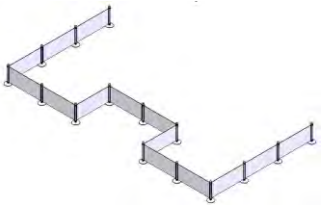
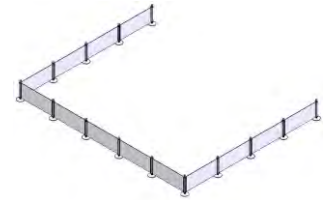
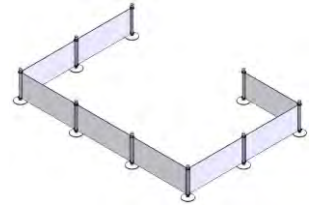

Crown Barrier Post

Base (mm)	Tube (mm)	Height (mm)
Φ320	Φ51	1000

Option:
- Accept customized post

Screen

Option:
- Material: Canvas, PVC, Mesh
- Printing: one side or two sides
- Accept customized size and color

OPTION



#803 601

- Board size 510 x 625 mm
- Dia.50mm post
- Dia.360 mm flat base
- Total height 1280 mm



#803 603

Signage Stand

- Board size 345 x 345 mm
- Dia.25mm post
- Total height 1520 mm



#803 604

- Board size A4, 210 x 295 mm
- Dia.25mm post
- Dia.250 mm flat base
- Total height 860-1250 mm





Sign Post Holder **HOT**

Vertically direction in **A4 size**
Polished finish - **(#204 401)**

Vertically direction in **A3 size**
Polished finish - **(#204 111)**

- A4 size, Golden finish **(#204 402)**
- A3 size, Golden finish **(#204 112)**

Option:
- Horizontal direction



Sign Post Holder **HOT**

Vertically direction in **A4 size**
Polished finish - **(#205 401)**

Vertically direction in **A3 size**
Polished finish - **(#205 411)**

Option:
- Golden finish
- Horizontal direction



Sign Post Holder **HOT**

Vertically direction in **A4 size**
Polished finish - **(#206 401)**

Vertically direction in **A3 size**
Polished finish - **(#206 411)**

Option:
- Golden finish
- Horizontal direction



Sign Post Holder **HOT**

Vertically direction in **A4 size**
Polished finish - **(#207 401)**

Vertically direction in **A3 size**
Polished finish - **(#207 411)**

Option:
- Horizontal direction



PVC Sign Holder **HOT**

Vertically direction in **A4 size**
Polished finish - **(#209 401)**

Belt color optional in:



#215 600
Merchandizing
Bowl



**Wall Mounted
Barrier Post**

Belt length available
in 2m **(#333 200)**
in 3m **(#333 300)**
in 5m **(#333 500)**



#271 101 (2~5 M)
Press one button to
change belt head
Convenient and fast!



#271 301
(2/3/5/10 M)
Plastic Wall Mount



#271 201 (2~3 M)
Removable Wall Mount,
easy to change



#271 301
(2/3/5/10 M)
Plastic Wall Mount



c a t e r i n g

COOKWARE



COOKWARE PROFI LINE

- Encapsulated bottom of aluminum with stainless steel
- Induction cooking suitable
- Dishwasher safe

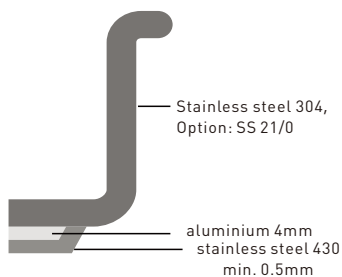
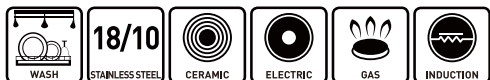

STOCK POT W/O LID, HIGH

Item No.	mm	Liter	Body.T (mm)
SP2424	Φ240x(H)240	10.0	0.8
SP2826	Φ280x(H)260	16.0	0.8
SP3232	Φ320x(H)320	25.0	1.0
SP3636	Φ360x(H)360	36.0	1.0
SP4040	Φ400x(H)400	50.0	1.0
SP4545	Φ450x(H)450	70.0	1.2
SP5050	Φ500x(H)500	100.0	1.2



STOCK POT W/O LID, MEDIUM

Item No.	mm	Liter	Body.T (mm)
SP2420	Φ240x(H)200	9.0	0.8
SP2622	Φ260x(H)225	12.0	0.8
SP3026	Φ300x(H)260	18.0	0.8
SP3226	Φ320x(H)260	20.0	0.8
SP3426	Φ340x(H)265	24.0	0.8
SP3630	Φ360x(H)305	30.0	0.8
SP4030	Φ400x(H)305	38.0	0.8



STOCK POT W/O LID, LOW

Item No.	mm	Liter	Body.T (mm)
CA1612	Φ160x(H)120	2.5	0.8
CA2014	Φ200x(H)140	4.0	0.8
CA2416	Φ240x(H)160	7.0	0.8
CA2818	Φ280x(H)180	10.0	0.8
CA3220	Φ320x(H)200	15.0	0.8
CA3622	Φ360x(H)220	22.0	1.0
CA4025	Φ400x(H)250	28.0	1.0
CA4528	Φ450x(H)280	44.0	1.2
CA5032	Φ500x(H)320	60.0	1.2
CA6035	Φ600x(H)350	98.0	1.2

COOKWARE PROFI LINE

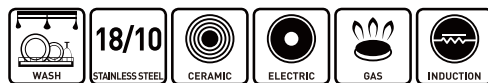

CASSEROLE W/O LID

Item No.	mm	Liter	Body.T (mm)
SW1609	Φ160x(H)95	1.9	0.8
SW2010	Φ200x(H)105	3.3	0.8
SW2411	Φ240x(H)110	5.0	0.8
SW2813	Φ280x(H)130	8.0	0.8
SW3216	Φ320x(H)160	12.0	1.0
SW3611	Φ360x(H)110	10.0	1.0
SW4013	Φ400x(H)130	15.0	1.0
SW4514	Φ450x(H)140	20.0	1.0
SW5016	Φ500x(H)160	30.0	1.0
SW6025	Φ600x(H)250	56.0	1.2



SAUCE PAN W/O LID, HIGH

Item No.	mm	Liter	Body.T (mm)
SA1612	Φ160x(H)120	2.4	0.8
SA2014	Φ200x(H)140	4.0	0.8
SA2416	Φ240x(H)160	7.0	0.8
SA2818	Φ280x(H)180	11.0	0.8



SAUCE PAN W/O LID, MEDIUM

Item No.	mm	Liter	Body.T (mm)
SA1609	Φ160x(H)95	1.5	0.8
SA2010	Φ200x(H)105	3.0	0.8
SA2411	Φ240x(H)110	5.0	0.8



SAUTÉ PAN W/O LID

Item No.	mm	Liter	Body.T (mm)
CO1606	Φ160x(H)60	1.0	0.8
CO2006	Φ200x(H)65	1.6	0.8
CO2407	Φ240x(H)75	2.7	0.8



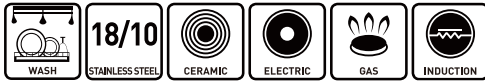

COOKWARE PROFI LINE



LIDS FOR PAN

Item No.	mm
SPLID14	Φ140
SPLID16	Φ160
SPLID18	Φ180
SPLID20	Φ200
SPLID24	Φ240
SPLID26	Φ260
SPLID28	Φ280
SPLID30	Φ300
SPLID32	Φ320
SPLID34	Φ340
SPLID36	Φ360
SPLID40	Φ400
SPLID45	Φ450
SPLID50	Φ500
SPLID60	Φ600

FRYING PAN W/O LID

Item No.	mm	Body.T (mm)
FP20	Φ200x(H)43	0.8
FP24	Φ240x(H)48	0.8
FP28	Φ280x(H)53	0.8
FP32	Φ320x(H)55	1.0
FP36	Φ360x(H)65	1.0 (w/ helper)
FP40	Φ400x(H)70	1.0 (w/ helper)

FRYING PAN W/O LID, EXCALIBUR NONSTICK

Item No.	mm	Body.T (mm)
FP20NS	Φ200x(H)43	0.8
FP24NS	Φ240x(H)48	0.8
FP28NS	Φ280x(H)53	0.8
FP32NS	Φ320x(H)55	1.0
FP36NS	Φ360x(H)65	1.0 (w/ helper)
FP40NS	Φ400x(H)70	1.0 (w/ helper)



PASTA COOKER BASKET

Item No.	mm	Liter
SSPC-01	160x(H)230	1.5

With extra hook to support while draining

PS: Suitable for stew pan Φ360mm



PASTA COOKER BASKET

Item No.	mm
SSPC-02	170x90x(H)138
SSPC-03	180x90x(H)138

Body in SS 304 , handle in SS 201

PS: Suitable for stew pan Φ200mm

COOKWARE ECO LINE

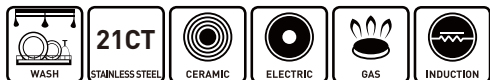

STOCK POT WITH LID, HIGH

Item No.	mm	Liter	Body.T (mm)
CT1612	Φ160x(H)120	2.5	0.8
CT2020	Φ200x(H)200	6	0.8
CT2420	Φ240x(H)200	9	0.8
CT2525	Φ250x(H)250	12	0.8
CT2825	Φ280x(H)250	15	0.8
CT2828	Φ280x(H)280	17	0.8
CT3030	Φ300x(H)300	21	0.8
CT3226	Φ320x(H)260	20	0.8
CT3232	Φ320x(H)320	25	0.8
CT3636	Φ360x(H)360	36	1.0
CT4040	Φ400x(H)400	50	1.0
CT4545	Φ450x(H)450	71	1.2
CT5050	Φ500x(H)500	98	1.2
CT5555	Φ550x(H)550	130	1.2
CT6060	Φ600x(H)600	170	1.2

STOCK POT WITH LID, MEDIUM

Item No.	mm	Liter	Body.T (mm)
CT1609	Φ160x(H)95	1.9	0.8
CT2014	Φ200x(H)140	4.4	0.8
CT2416	Φ240x(H)160	7.2	0.8
CT2818	Φ280x(H)180	11	0.8
CT3020	Φ300x(H)200	14	0.8
CT3222	Φ320x(H)220	17	0.8
CT3624	Φ360x(H)240	24	1.0
CT4030	Φ400x(H)300	37	1.0
CT4536	Φ450x(H)360	57	1.2
CT5032	Φ500x(H)320	62	1.2
CT5535	Φ550x(H)350	83	1.2
CT6040	Φ600x(H)400	113	1.2

STOCK POT WITH LID, LOW

Item No.	mm	Liter	Body.T (mm)
CT2010	Φ200x(H)105	3.3	0.8
CT2411	Φ240x(H)110	5	0.8
CT2813	Φ280x(H)130	8	0.8
CT3216	Φ320x(H)160	12.9	0.8
CT3618	Φ360x(H)180	18.3	1.0
CT4025	Φ400x(H)250	31.4	1.0
CT4528	Φ450x(H)280	44	1.2
CT5030	Φ500x(H)300	58	1.2

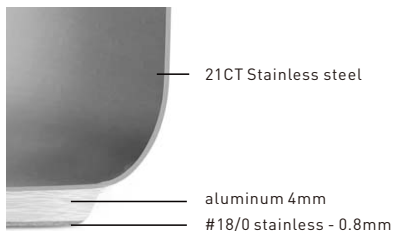

Advantages of 21CT Stainless Steel

- Conducts heat 30% faster than standard 18/8 stainless
- Performs on all stovetops - electric, gas and magnetic induction
- LFGB approved for food preparation of all types
- Stronger, improved construction resists stress cracks
- Nickel free



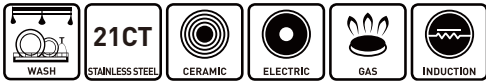

COOKWARE ECO LINE



STEW POT WITH LID

Item No.	mm	Liter	Body.T (mm)
CTC3611	Φ360x(H)110	11.2	0.8



SAUCE PAN WITH LID, HIGH

Item No.	mm	Liter	Body.T (mm)
CTC1207	Φ120x(H)75	0.8	0.8
CTC1408	Φ140x(H)85	1.3	0.8
CTC1609	Φ160x(H)95	1.9	0.8
CTC1811	Φ180x(H)110	2.8	0.8
CTC2012	Φ200x(H)120	3.7	0.8
CTC2213	Φ220x(H)130	4.9	0.8
CTC2414	Φ240x(H)140	6.3	0.8
CTC2615	Φ260x(H)150	7.9	0.8
CTC2816	Φ280x(H)160	9.8	0.8
CTC3018	Φ300x(H)180	12.7	0.8



SAUCE PAN WITH LID, MEDIUM

Item No.	mm	Liter	Body.T (mm)
CTC2010	Φ200x(H)105	3.3	0.8
CTC2411	Φ240x(H)110	5	0.8
CTC2813	Φ280x(H)130	8	0.8



SAUCE PAN WITH LID, LOW

Item No.	mm	Liter	Body.T (mm)
CTC1205	Φ120x(H)50	0.5	0.8
CTC1405	Φ140x(H)55	0.8	0.8
CTC1606	Φ160x(H)60	1.2	0.8
CTC1806	Φ180x(H)65	1.6	0.8
CTC2007	Φ200x(H)75	2.3	0.8
CTC2207	Φ220x(H)75	2.8	0.8
CTC2408	Φ240x(H)80	3.6	0.8
CTC2608	Φ260x(H)85	4.5	0.8
CTC2809	Φ280x(H)95	5.8	0.8
CTC3010	Φ300x(H)105	7.4	0.8

COOKWARE ECO LINE

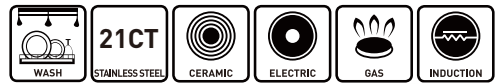

helper



helper

FRYING PAN W/O LID

Item No.	mm	Body.T (mm)
CTF16	Φ160x(H)40	0.8
CTF18	Φ180x(H)40	0.8
CTF20	Φ200x(H)40	0.8
CTF22	Φ220x(H)41	0.8
CTF24	Φ240x(H)45	0.8
CTF26	Φ260x(H)47	0.8
CTF28	Φ280x(H)48	0.8
CTF30	Φ300x(H)49	0.8
CTF32	Φ320x(H)50	0.8
CTF36	Φ360x(H)53	0.8, w/ helper
CTF40	Φ400x(H)55	0.8, w/ helper

FRYING PAN W/O LID, TEFLON COATING

Item No.	mm	Body.T (mm)
CTF16N	Φ160x(H)40	0.8
CTF18N	Φ180x(H)40	0.8
CTF20N	Φ200x(H)40	0.8
CTF22N	Φ220x(H)41	0.8
CTF24N	Φ240x(H)45	0.8
CTF26N	Φ260x(H)47	0.8
CTF28N	Φ280x(H)48	0.8
CTF30N	Φ300x(H)49	0.8
CTF32N	Φ320x(H)50	0.8
CTF36N	Φ360x(H)53	0.8, w/ helper
CTF40N	Φ400x(H)55	0.8, w/ helper



SAUTÉ PAN

Item No.	mm	Liter	Body.T (mm)
CTS2006	Φ200x(H)65	1.2	0.8
CTS2407	Φ240x(H)75	2.2	0.8



PASTA COOKER BASKET

Item No.	mm
PCB-30	Φ300x(H)180, 4PCS FOR 1 SET, for Φ320 pan
PCB-34	Φ340x(H)190, 4PCS FOR 1 SET, for Φ360 pan
PCB-38	Φ380x(H)200, 4PCS FOR 1 SET, for Φ400 pan

LID (SS 201)



Item No.	mm	Item No.	mm
CTL12	Φ120	CTL24	Φ240
CTL14	Φ140	CTL26	Φ260
CTL16	Φ160	CTL28	Φ280
CTL18	Φ180	CTL30	Φ300
CTL20	Φ200	CTL32	Φ320
CTL22	Φ220	CTL36	Φ360
		CTL40	Φ400
		CTL45	Φ450
		CTL50	Φ500
		CTL55	Φ550
		CTL60	Φ600

BLACK IRON COOKWARE

- Traditional cookware is made of black iron steel.
- Light, Simple, quality, firmness and versatility, make it easy to lift and shake with one hand.
- Ideal for fast heating and cooking.
- For all cook tops including induction.
- CARE: Deglaze, rinse with warm water, dry and oil lightly. Store in a dry place. Do not use detergents or put in the dishwasher.

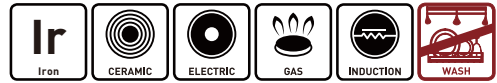

FRYING PANS

Item No.	mm	bottom(mm)	thickness (mm)
FP1024	Φ200x(H)50	160	1.6
FP1026	Φ260x(H)50	200	1.6
FP1027	Φ300x(H)50	240	1.6
FP1028	Φ360x(H)50 (w/helper)	300	1.6



BLINIS PAN

Item No.	mm	Φb(mm)	T (mm)
FP1023	Φ140x(H)40	105	1.6

CRÊPES PAN

Item No.	mm	Φb(mm)	T (mm)
FP1025	Φ240x(H)26	200	1.6

OMELETTE PANS

Item No.	mm	Φb(mm)	T (mm)
FP1029	Φ200x(H)40	170	1.6
FP1030	Φ260x(H)45	200	1.6

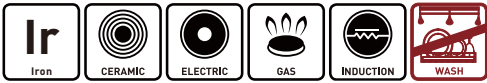

BLACK IRON COOKWARE

- CARE: Deglaze, rinse with warm water, dry and oil lightly. Store in a dry place. Do not use detergents or put in the dishwasher.

HAMMERED BOTTOM PAELLA PAN

Item No.	mm	bottom(mm)	thickness (mm)
BICP36	Φ360x(H)45	305	1.0
BICP46	Φ460x(H)48	410	1.0
BICP60	Φ600x(H)52	540	1.0
BICP80	Φ800x(H)52	740	1.0



CONVENTIONAL CRAFT (RIVET)



OPTION: SOLID WELDING

CUSTOMIZED PANS AVAILABLE



ALUMINIUM COOKWARE

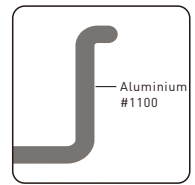
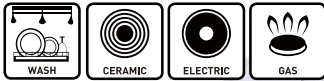

STOCK POT WITH LID, ROLLED RIM

Item No.	mm	Cap.(Qt)	T (mm)
AS1412	Φ140x(H)120	2	0.6
AS1813	Φ180x(H)130	3.5	0.6
AS2214	Φ220x(H)140	5	0.6
AS2417	Φ240x(H)173	8	0.7
AS2621	Φ260x(H)215	12	0.8
AS2824	Φ280x(H)245	16	0.8
AS2926	Φ295x(H)265	20	0.8
AS3227	Φ320x(H)275	24	0.9
AS3331	Φ330x(H)290	28	1.0

Item No.	mm	Cap.(Qt)	T (mm)
AS3531	Φ350x(H)315	32	1.0
AS3833	Φ380x(H)335	40	1.0
AS4136	Φ410x(H)365	52	1.0
AS4338	Φ435x(H)380	60	1.2
AS4940	Φ490x(H)400	80	1.2
AS5244	Φ520x(H)440	100	1.3
AS5745	Φ570x(H)450	120	1.5
AS6045	Φ605x(H)450	140	1.8
AS6051	Φ605x(H)515	160	1.8

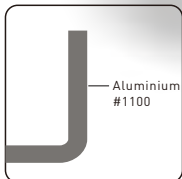

STOCK POT WITH LID, CUT RIM

Item No.	mm	Cap.(Qt)	T (mm)
AP2416	Φ240x(H)168	8	2.6
AP2621	Φ260x(H)215	12	2.6
AP2824	Φ280x(H)245	16	2.6
AP3027	Φ300x(H)270	20	2.6
AP3129	Φ315x(H)290	24	2.6
AP3331	Φ330x(H)310	28	2.6
AP3531	Φ350x(H)315	32	2.6
AP3833	Φ380x(H)335	40	2.6
AP4136	Φ410x(H)365	52	3.5
AP4338	Φ435x(H)380	60	3.5
AP4940	Φ490x(H)400	80	4.0
AP5244	Φ520x(H)440	100	4.0

ALUMINIUM COOKWARE

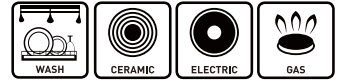

STOCK POT WITH LID, LOW

Item No.	mm	Cap.(qt)	T (mm)
ASP1407	Φ140x(H)73	1.2	1.8
ASP1610	Φ160x(H)100	2.2	1.8
ASP1810	Φ180x(H)105	2.8	1.8
ASP2010	Φ200x(H)100	4	1.8
ASP2211	Φ220x(H)110	5	1.8
ASP2412	Φ240x(H)120	6.5	1.8
ASP2613	Φ260x(H)130	8	1.8
ASP3013	Φ300x(H)130	10	1.8
ASP3813	Φ350x(H)130	15	1.8
ASP4113	Φ410x(H)130	18	1.8



SAUCE PAN W/O LID

Item No.	mm	Cap.(qt)	T (mm)
SAP1609	Φ160x(H)90	1.9	3.0
SAP1810	Φ180x(H)100	2.6	3.0
SAP2011	Φ200x(H)110	3.4	3.0
SAP2212	Φ220x(H)120	4.7	3.0
SAP2413	Φ240x(H)130	6.1	3.0
SAP2614	Φ260x(H)140	7.8	3.0



SAUCE PAN W/O LID

Item No.	mm	Cap.(qt)	T (mm)
SBP1510	Φ156x(H)105	1.9	2.0
SBP1911	Φ190x(H)115	3.4	2.0
SBP2212	Φ220x(H)125	5	2.0
SBP2313	Φ233x(H)135	5.9	2.0
SBP2414	Φ243x(H)145	6.9	2.0
SBP2715	Φ273x(H)155	9.3	2.0
SBP2916	Φ298x(H)167	12	2.0



ALUMINIUM COOKWARE



FRY PAN WITH IRON HANDLE

Item No.	mm	T (mm)
AFP16	Φ160x(H)45	3.5
AFP18	Φ180x(H)45	3.5
AFP20	Φ200x(H)47	3.5
AFP22	Φ220x(H)47	3.5
AFP24	Φ240x(H)47	3.5
AFP26	Φ260x(H)47	3.5
AFP28	Φ280x(H)47	3.5
AFP30	Φ300x(H)47	3.5
AFP32	Φ320x(H)47	3.5
AFP35	Φ350x(H)50	3.5



FRY PAN WITH IRON HANDLE, NON-STICK

Item No.	mm	T (mm)
AFP16N	Φ160x(H)45	3.5
AFP18N	Φ180x(H)45	3.5
AFP20N	Φ200x(H)47	3.5
AFP22N	Φ220x(H)47	3.5
AFP24N	Φ240x(H)47	3.5
AFP26N	Φ260x(H)47	3.5
AFP28N	Φ280x(H)47	3.5
AFP30N	Φ300x(H)47	3.5
AFP32N	Φ320x(H)47	3.5
AFP35N	Φ350x(H)50	3.5



FRY PAN WITH IRON HANDLE, NON-STICK

Item No.	mm	T (mm)
AFP16E	Φ120x(H)20	3.0
AFP18E	Φ140x(H)22	3.0
AFP20E	Φ180x(H)35	4.0
AFP22E	Φ220x(H)40	4.0
AFP24E	Φ240x(H)45	4.0
AFP26E	Φ260x(H)47	4.0
AFP28E	Φ280x(H)50	4.0
AFP30E	Φ300x(H)55	5.0
AFP32E	Φ350x(H)55	5.0
AFP35E	Φ380x(H)60	5.0

Gastronorm Container

According to EN 631

All pans are made of high grade stainless steel with a surface polished by electrolysis (satin-matt) and therefore highly suitable for professional operation.

Very solid design

Smooth edges, easy to clean



Can be used in convection ovens, refrigerators, bain-marie system and chafing dishes.

SGS

EN631 Gastronorm mm

GN 2 / 1	650 x 530
GN 1 / 1	530 x 325
GN 1 / 2	325 x 265
GN 1 / 3	325 x 176
GN 1 / 4	265 x 162
GN 1 / 6	176 x 162
GN 1 / 9	176 x 108
GN 2 / 3	354 x 325
GN 2 / 4	530 x 162

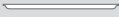
GN depth

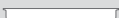
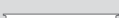
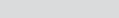
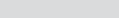
20 mm	
40 mm	
65 mm	
100 mm	
150 mm	
200 mm	

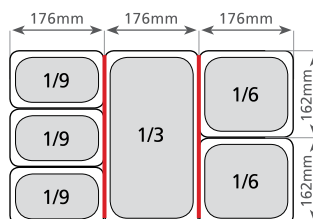
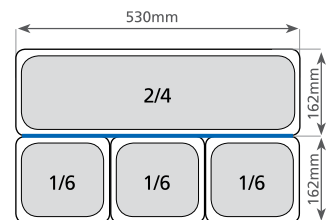
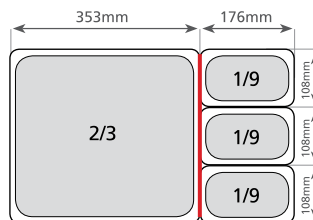
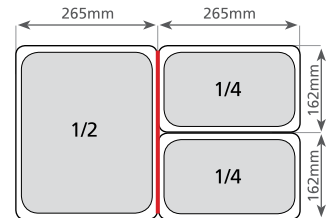
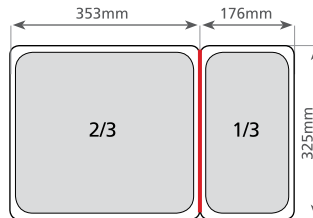
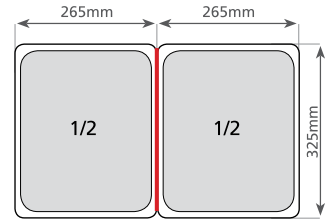
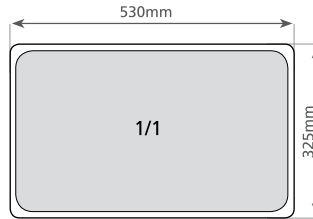

ADAPTOR BAR KEY

-  1/1
-  1/2



Gastronorm Container 2 / 1
-650x530mm

Item No.	H(mm)	Liter
GN21200	200	56.5
GN21150	150	42.5
GN21100	100	28.5
GN21065	65	18.5
GN21040	40	10.0
GN21020	20	5.0



Gastronorm Container 1 / 1
-530x325mm

Item No.	H(mm)	Liter
GN11200	200	28.0
GN11150	150	21.0
GN11100	100	14.0
GN11065	65	9.0
GN11040	40	5.0
GN11020	20	2.5



Gastronorm Container 2 / 4
-530x162mm

Item No.	H(mm)	Liter
GN24150	150	9.0
GN24100	100	6.0
GN24065	65	3.8
GN24040	40	2.0
GN24020	20	1.0



Gastronorm Container 2 / 3
-354x325mm

Item No.	H(mm)	Liter
GN23200	200	18.0
GN23150	150	13.0
GN23100	100	9.0
GN23065	65	5.5
GN23040	40	3.0
GN23020	20	1.5



Gastronorm Container 1 / 2
-325x265mm

Item No.	H(mm)	Liter
GN12200	200	12.5
GN12150	150	9.5
GN12100	100	6.5
GN12065	65	4.0
GN12040	40	2.0
GN12020	20	1.0



Gastronorm Container 1 / 3
-325x176mm

Item No.	H(mm)	Liter
GN13200	200	7.8
GN13150	150	5.7
GN13100	100	4.0
GN13065	65	2.5
GN13040	40	1.5
GN13020	20	0.7



Gastronorm Container 1 / 4
-265x162mm

Item No.	H(mm)	Liter
GN14200	200	5.5
GN14150	150	4.0
GN14100	100	2.8
GN14065	65	1.8
GN14040	40	1.1
GN14020	20	0.5



Gastronorm Container 1 / 6
-176x162mm

Item No.	H(mm)	Liter
GN16200	200	3.4
GN16150	150	2.4
GN16100	100	1.6
GN16065	65	1.0



Gastronorm Container 1 / 9
-176x108mm

Item No.	H(mm)	Liter
GN19500	150	1.5
GN19100	100	1.0
GN19065	65	0.6

Perforated GN Container



3.5 mm hole

	GN	mm
GN11020P	1 / 1	20
GN11040P	1 / 1	40
GN11065P	1 / 1	65
GN11100P	1 / 1	100
GN11150P	1 / 1	150
GN11200P	1 / 1	200
GN23040P	2 / 3	40
GN23065P	2 / 3	65
GN23100P	2 / 3	100
GN12040P	1 / 2	40
GN12065P	1 / 2	65
GN12100P	1 / 2	100
GN12150P	1 / 2	150
GN12200P	1 / 2	200
GN13040P	1 / 3	40
GN13065P	1 / 3	65
GN13100P	1 / 3	100
GN13150P	1 / 3	150
GN13200P	1 / 3	200

GN pans w/ folding handles round ergonomic handles



	GN	mm
11065FH	1 / 1	65
11100FH	1 / 1	100
11150FH	1 / 1	150
12065FH	1 / 2	65
12100FH	1 / 2	100
12150FH	1 / 2	150
13065FH	1 / 3	65
13100FH	1 / 3	100
13150FH	1 / 3	150
23065FH	2 / 3	65
23100FH	2 / 3	100
23150FH	2 / 3	150

GN Lids



	GN
GN11L	1 / 1
GN12L	1 / 2
GN13L	1 / 3
GN14L	1 / 4
GN16L	1 / 6
GN19L	1 / 9
GN23L	2 / 3
GN24L	2 / 4
GN21L	2 / 1

with notched for spoons



GN Lids w/ notched for spoons

	GN
GN11LS	1 / 1
GN12LS	1 / 2
GN13LS	1 / 3
GN14LS	1 / 4
GN16LS	1 / 6
GN19LS	1 / 9
GN23LS	2 / 3
GN24LS	2 / 4
GN21LS	2 / 1

GN Lid with rubber seal



	GN
GN11LR	1 / 1
GN12LR	1 / 2
GN13LR	1 / 3
GN14LR	1 / 4
GN16LR	1 / 6
GN23LR	2 / 3

GN Lids with cut out



	GN
GN11LC	1 / 1
GN12LC	1 / 2
GN13LC	1 / 3
GN14LC	1 / 4
GN16LC	1 / 6



Ice Cream pan

	mm
ISC12	360 x 250 x H150
ISC13	360 x 165 x H115
ISC12T	360 x 250 x H80
ISC13T	360 x 165 x H80



Coffee Grounds Pan

	mm
CGP01	176X162X150



Oven Tray

	GN
OTG1165	1 / 1 x 65mm
OTG1140	1 / 1 x 40mm
OTG1120	1 / 1 x 20mm
OTG1110	1 / 1 x 10mm



Drain Plate

	GN
DP11	1 / 1



Drain Shelf

	GN
DS11	1 / 1
DS23	2 / 3
DS12	1 / 2
DS13	1 / 3
DS14	1 / 4
DS16	1 / 6



GN Adaptor Bar for fixing GN pans

	mm
GN11BAR	530
GN12BAR	325



Bain-Marie Pan & Lid

	mm
P105 160	155x105x160
P105 075	155x105x75
P105 055	155x105x55
P105 L	155x105
P155 160	155x155x160
P155 075	155x155x75
P155 055	155x155x55
P155 L	155x155
P240 160	240x240x160
P240 075	240x240x75
P240 055	240x240x55
P240 L	240x240



Enameled GN Oven Tray

	mm
EG2102	GN2/1 x 20
EG2104	GN2/1 x 40
EG2106	GN2/1 x 65
EG2110	GN2/1 x 100
	mm
EG2302	GN2/3 x 20
EG2304	GN2/3 x 40
EG2306	GN2/3 x 65
EG2310	GN2/3 x 100
	mm
EG1102	GN1/1 x 20
EG1104	GN1/1 x 40
EG1106	GN1/1 x 65
EG1110	GN1/1 x 100

PP Containers



Item No.	mm	Height(mm)
----------	----	------------

Gastronorm Container 1 / 1

PP11200	530x325	200
PP11150	530x325	150
PP11100	530x325	100
PP11065	530x325	65

Gastronorm Container 1 / 2

PP12200	325x265	200
PP12150	325x265	150
PP12100	325x265	100
PP12065	325x265	65

Gastronorm Container 1 / 3

PP13200	325x176	200
PP13150	325x176	150
PP13100	325x176	100
PP13065	325x176	65

Gastronorm Container 1 / 4

PP14150	265x162	150
PP14100	265x162	100
PP14065	265x162	65

Gastronorm Container 1 / 6

PP16150	176x162	150
PP16100	176x162	100
PP16065	176x162	65

Gastronorm Container 1 / 9

PP19100	176x108	100
PP19065	176x108	65

LID

PP11L
PP12L
PP13L
PP14L
PP16L
PP19L



DRAIN SHELF

PP11DS	460x250x15
PP12DS	256x196x15
PP13DS	250x100x15
PP14DS	210x108x15
PP16DS	120x108x15

LID WITH NOTCHED

PP11LN
PP12LN
PP13LN
PP14LN
PP16LN
PP19LN



SEAL LID

PP11LS
PP12LS
PP13LS
PP14LS
PP16LS
PP19LS

PC Containers

Item No. **mm** **Height(mm)**

Gastronorm Container 1 / 1

PC11200	530x325	200
PC11150	530x325	150
PC11100	530x325	100
PC11065	530x325	65

Gastronorm Container 1 / 2

PC12200	325x265	200
PC12150	325x265	150
PC12100	325x265	100
PC12065	325x265	65

Gastronorm Container 1 / 3

PC13200	325x176	200
PC13150	325x176	150
PC13100	325x176	100
PC13065	325x176	65

Gastronorm Container 1 / 4

PC14150	265x162	150
PC14100	265x162	100
PC14065	265x162	65

Gastronorm Container 1 / 6

PC16150	176x162	150
PC16100	176x162	100
PC16065	176x162	65

Gastronorm Container 1 / 9

PC19100	176x108	100
PC19065	176x108	65



LID

- PC11L
- PC12L
- PC13L
- PC14L
- PC16L
- PC19L



LID W/ NOTCHED

- PC11LN
- PC12LN
- PC13LN
- PC14LN
- PC16LN
- PC19LN



DRAIN SHELF

- PC11DS 460x250x15
- PC12DS 256x196x15
- PC13DS 250x100x15
- PC14DS 210x108x15
- PC16DS 120x108x15



Item No.	mm	Height(mm)
Gastronorm Container 1 / 1		
MF11100	530x325	100
MF11065	530x325	65
MF11040	530x325	40
Gastronorm Container 1 / 2		
MF12100	325x265	100
MF12065	325x265	65
MF12040	325x265	40
Gastronorm Container 1 / 3		
MF13100	325x176	100
MF13065	325x176	65
Gastronorm Container 1 / 4		
MF14100	265x162	100
MF14065	265x162	65
Gastronorm Container 1 / 6		
MF16100	176x162	100
MF16065	176x162	65
Gastronorm Container 2 / 3		
MF23065	354x325	65
Gastronorm Container 2 / 4		
MF24065	530x162	65

Melamine Containers



STANDERD

P011025	GN1/1 x 25mm
P011065	GN1/1 x 65mm
P023065	GN2/3 x 65mm
P012025	GN1/2 x 25mm
P012065	GN1/2 x 65mm
P013065	GN1/3 x 65mm



Porcelain Containers

ROUND

P030-65	Dia.330 x 65mm
P035-65	Dia.390 x 65mm



Divided

P011065-2	GN1/1 x 65mm
P023065-2	GN2/3 x 65mm



Round Divided

P030-65-2	Dia.330 x 65mm
P035-65-2	Dia.390 x 65mm





c a t e r i n g

Kitchen ware



HACCP CUTTING BOARDS

- Made of polyethylene LDPE.
- Meets HACCP standards.



CUTTING BOARD GN 1/1

- smooth two-sided, 530x325x(H)12.7mm

Color	Item No.	for
	KU6677R	raw meat
	KU6677B	fish
	KU6677T	cooked meat
	KU6677G	fruits, vegetables
	KU6677Y	raw poultry
	KU6677W	cheese, bread

CUTTING BOARD GN 1/2

- smooth two-sided, 325x265x(H)12.7mm

Color	Item No.	for
	KU6676R	raw meat
	KU6676B	fish
	KU6676T	cooked meat
	KU6676G	fruits, vegetables
	KU6676Y	raw poultry
	KU6676W	cheese, bread

CUTTING BOARD 450x300

- smooth two-sided, 450x300x(H)12.7mm

Color	Item No.	for
	KU6679	raw meat
	KU6680	fish
	KU6681	cooked meat
	KU6682	fruits, vegetables
	KU6683	raw poultry
	KU6684	cheese, bread

CUTTING BOARD RACK

- for 6 pcs cutting boards up to 20mm thick

Item No.		mm
KU6685	chrome-plated	300x270x(H)270
KU6720	stainless steel	300x270x(H)270

HACCP CUTTING BOARDS

- Made of polyethylene LDPE.
- Meets HACCP standards.



CUTTING BOARD GN 1/2

- one side with groove, 325x265x(H)12mm

Color	Item No.	for
	KU6686	raw meat
	KU6687	fish
	KU6688	cooked meat
	KU6689	fruits, vegetables
	KU6690	raw poultry
	KU6691	cheese, bread

CUTTING BOARD GN 1/1

- one side with groove, 530x325x(H)15mm

Color	Item No.	for
	KU6692	raw meat
	KU6693	fish
	KU6694	cooked meat
	KU6695	fruits, vegetables
	KU6696	raw poultry
	KU6697	cheese, bread

CUTTING BOARD 600x400

- one side with groove, 600x400x(H)18mm

Color	Item No.	for
	KU6698	raw meat
	KU6699	fish
	KU6700	cooked meat
	KU6701	fruits, vegetables
	KU6702	raw poultry
	KU6703	cheese, bread

CUTTING BOARD IN BLACK

- for use in smoking, grilling, BBQ, making sushi etc

Item No.	Description	mm
KU6704	Smooth board	450x300x(H)13
KU6705	Board with one groove	325x265x(H)12
KU6706	Board with one groove	530x325x(H)15
KU6707	Board with one groove	600x400x(H)18

CUTTING BOARD WITH FEET

- smooth boards with carrying handle and non-slip feet

Item No.	Description	mm
KU6708	no feet	250x150x(H)10
KU6709	no feet	300x220x(H)10
KU6710	with feet	350x250x(H)20
KU6711	with feet	440x290x(H)20
KU6712	with feet	500x340x(H)20
KU6713	with feet	600x390x(H)20

WOODEN CUTTING BOARDS

- Made of wooden.
- Meets food grade standards.



CUTTING BOARD WOOD

Item No.	mm
KU6951	265x325x45
KU6952	530x325x45



CARVING BOARD

Item No.	mm
KU6953	340x200x16



BREAD BOARD

Item No.	mm
KU6954	340x200x14



BAGUETTE BOARD

Item No.	mm
KU6955	530x325x20



CUTTING BOARD WITH GRIP

Item No.	mm
KU6956	390x160x13



BAGUETTE BOARD

Item No.	mm
KU6957	475x322x20

KNIVES PROFI LINE

- All knives are precision hot drop forged from high carbon stainless steel.
- The ergonomic black POM handle provides users with exceptional comfort and a firm grip for added safety in your kitchen.
- Perfectly made and perfectly balanced



No.	Item No.	Product name	L (mm)
1	KU6752	Kitchen knife	200
	KU6752F	Kitchen knife	250
2	KU6753	Corrugated kitchen knife	200
3	KU6754	Kitchen knife	230
4	KU6755	Boning knife	150
5	KU6756	Boning knife	115
6	KU6757	Peeling knife	90
7	KU6758	Vegetable knife	65
8	KU6759	Bread knife	210
9	KU6760	Cake knife	250

No.	Item No.	Product name	L (mm)
10	KU6761	Cleaver	180
11	KU6762	Corrugated cleaver	180
12	KU6763	Santoku knife	180
13	KU6764	Corrugated Santoku knife	130
14	KU6765	Knife of soft cheeses with holes	160
15	KU6766	Straight fork	150
16	KU6767	Curved fork	150
17	KU6768	Diamond steel	255
18	KU6796	Knives set in cover	

KNIVES KITCHEN LINE

- All knives are precision hot drop forged from high carbon stainless steel.
- The ergonomic black POM handle provides users with exceptional comfort and a firm grip for added safety in your kitchen.
- Perfectly made and perfectly balanced



This set includes knives:
NO.1,2,3,4,8,9
Knives set in cover

No.	Item No.	Product name	L (mm)
1	KU6797	KITCHEN KNIFE	200
	KU6910	KITCHEN KNIFE	250
	KU6911	KITCHEN KNIFE	300
2	KU6798	MEAT KNIFE	130
	KU6912	MEAT KNIFE	200
3	KU6799	FILLETING KNIFE	155
	KU6713S	FILLETING KNIFE	180

No.	Item No.	Product name	L (mm)
4	KU6800	BREAD KNIFE	200
5	KU6801	STEAK/TOMATO KNIFE	115
6	KU6802	PEELING KNIFE	100
7	KU6803	VEGETABLE KNIFE	80
8	KU6804	FORK	180
9	KU6805	STEEL	250
10	KU6806	FORGED KNIVES SET	

KNIVES KITCHEN LINE

- All knives are precision hot drop forged from high carbon stainless steel.
- The ergonomic black POM handle provides users with exceptional comfort and a firm grip for added safety in your kitchen.
- Perfectly made and perfectly balanced



1



5



2



6



3



7



4



8



9



10



No.	Item No.	Product name	L (mm)
1	KU6807	Kitchen knife	210
	KU6913	Kitchen knife	240
2	KU6808	Roasting knife	200
3	KU6809	Bread knife	195
4	KU6810	Boning knife	150
5	KU6811	Peeling knife	100
	KU6914	Peeling knife	115
6	KU6812	Vegetable knife	75

No.	Item No.	Product name	L (mm)
7	KU6813	Fork	150
8	KU6726	Poultry shears	250
9	KU6814	Steel	250
	KU6915	Steel	300
10	MKR300	Knife magnet with hooks	300
	MKR450	Knife magnet with hooks	450
	MKR600	Knife magnet with hooks	600

JAPANESE KNIVES

- All knives are precision hot drop forged from high carbon stainless steel.
- The ergonomic black POM handle provides users with exceptional comfort and a firm grip for added safety in your kitchen.
- Perfectly made and perfectly balanced









No.	Item No.	Product name	L (mm)
1	KU6815	Sashimi knife	210
	KU6916	Sashimi knife	240
2	KU6816	Naikiri knife	180
3	KU6817	Santoku knife	165
4	KU6818	Deba knife	150

PREMIUM HACCP KNIVES

- Made of high quality X50CrMoV15 steel.
- The ergonomic PP handle
- Perfectly made and perfectly balanced



KITCHEN KNIFE 300MM

Color	Item No.
	KU6819
	KU6820
	KU6821
	KU6822
	KU6823
	KU6824



KITCHEN KNIFE 250MM

Color	Item No.
	KU6825
	KU6826
	KU6827









KITCHEN KNIFE 200MM

Color	Item No.
	KU6828
	KU6829
	KU6830



STEEL 250MM

Color	Item No.
	KU6831
	KU6832
	KU6833
	KU6834
	KU6835
	KU6836



PREMIUM HACCP KNIVES

CUTTING KNIFE 180MM

Color Item No.



KU6837
KU6838
KU6839
KU6840
KU6841
KU6842



UTILITY KNIFE 180MM

Color Item No.



KU6843
KU6844
KU6845
KU6846
KU6847
KU6848



UTILITY KNIFE 150MM

Color Item No.



KU6849
KU6850
KU6851
KU6852
KU6853
KU6854



PEELING KNIFE 90MM

Color Item No.



KU6855
KU6856
KU6857
KU6858
KU6859
KU6860



VEGETABLE KNIFE 100MM

Color Item No.



KU6917



VEGETABLE KNIFE 60MM

Color Item No.



KU6918



PREMIUM HACCP KNIVES

MEAT KNIFE 200MM

Color Item No.



KU6919
KU6920
KU6921



BONING KNIFE 150MM

Color Item No.



KU6922
KU6861
KU6862



BONING KNIFE 150MM

Color Item No.



KU6863
KU6864
KU6865



CLEAVER 180MM

Color Item No.



KU6866
KU6867



CLEAVER 300MM

Color Item No.



KU6868



KITCHEN KNIFE SERRATED 310MM

Color Item No.



KU6869



PREMIUM HACCP KNIVES

BUTCHER'S KNIFE

Color Item No.

	250MM	KU6870
	300MM	KU6871



BUTCHER'S KNIFE CURVED 250MM

Color Item No.

		KU6872
---	--	---------------



BREAD KNIFE

Color Item No.

	250MM	KU6875
	300MM	KU6876



CHEESE KNIFE 360MM

Color Item No.

		KU6877
---	--	---------------

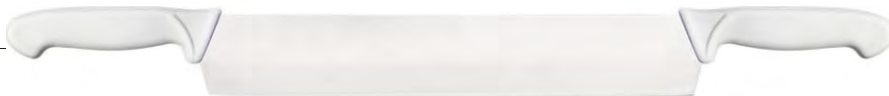

SOFT CHEESE KNIFE 150MM

Color Item No.

		KU6878
---	--	---------------



HACCP KNIVES OF ROLLED STEEL

1. UTILITY KNIFE 160MM

Color _____ Item No. _____



KU6879
KU6880
KU6881
KU6882
KU6883
KU6884



2. KITCHEN KNIFE 220MM

Color _____ Item No. _____



KU6885
KU6886
KU6887
KU6888
KU6889
KU6890



3. KITCHEN KNIFE 250MM

Color _____ Item No. _____



KU6891
KU6892
KU6893
KU6894
KU6895
KU6896



4. UTILITY KNIFE

Color _____ Item No. _____



200MM KU6897
300MM KU6898



5. CUTTING KNIFE 160MM

Color _____ Item No. _____



KU6899
KU690A



6. PEELING KNIFE 90MM

Color _____ Item No. _____



KU6900
KU6901
KU6902



7. PEELING KNIFE 100MM

Color _____ Item No. _____



KU6903



8. VEGETABLE KNIFE 105MM

Color _____ Item No. _____



KU6923



9. BREAD ROLL KNIFE 85MM

Color _____ Item No. _____



KU6924





CUT RESISTANT GLOVES

- Made of the mix of HPPE, polyester fibres and nylon

Item No.	Description
KU6904	Medium
KU6905	Large



OYSTER GLOVE

Consists of 2 gloves, a cotton inner glove, the stainless steel chain mail outer glove

Item No.	Description
KU6906	Medium
KU6907	Large



STEEL GLOVE

stainless steel

Item No.	Description
KU6916	Medium
KU6917	Large



MINCING KNIFE

- Made of PP handle, stainless steel blade

Item No.	Description	mm
KU6908	Single	230
KU6791	Double	230



KNIFE SHARPENER

- 3 functions for sharpening knives, "ceramic", "coarse", "fine"

Item No.	mm
KU6795	200x46x(H)75



MEAT TENDERIZER

- Blades (35mm) in two rows
- Meat fibers are being cut, not crushed

Item No.	Description	mm
KU6714		150x35x(H)115
KU6715		150x35x(H)115



MEAT MALLET

- Made of aluminum
- Two crushing surface

Item No.	Description	mm
KU6718		277x75x59
KU6719	Non-slip handle	277x75x59



OYSTER KNIFE

- Made of stainless steel and pom

Item No.	Description	mm
KU672R	ROUND	170
KU672S	STRAIGHT	160



KITCHEN SCISSORS

Item No.	mm
KU6721	140
KU6722	212
KU6723	245



POULTRY SHEARS

Item No.	mm
KU6727	240



POULTRY SHEARS

Item No.	mm
KU6726	250



KITCHEN SCISSORS

Item No.	mm
KU6724	212



HERB SCISSORS

Item No.	mm
KU6725	200

DECORATION KNIVES

- Large selection of professional decoration knives
- Ergonomic plastic handles



This set includes knives:
NO. 1,6,7,8,12,14
Knives set in cover

No.	Item No.	Product name	L (mm)
1	KU6772	LEMON ZESTER	155
2	KU6773	GRAPEFRUIT KNIFE	110/215
3	KU6774	VEGETABLE CORER	110/220
4	KU6775	CITRUS PEELER	180
5	KU6776	MELON SCOOP OVAL	Φ26x165
6	KU6777	MELON SCOOP SERRATED	Φ22x155
7	KU6779	CHANNEL KNIFE	150
8	KU6778	MELON SCOOP DOUBLE	Φ22-25x165
9	KU6785	DOUGH CUTTER	Φ60x180

No.	Item No.	Product name	L (mm)
10	KU6787	BUTTER CURLER	200
11	KU6780	POTATO PEELER	175
12	KU6781	DECORATION KNIFE	200
13	KU6782	TOMATO KNIFE OFFSET	230
14	KU6784	APPLE CORER	215
15	KU6789	CHEESE KNIFE FOR SOFT CHEESE	160/270
16	KU6790	CHEESE KNIFE FOR HARD CHEESE	130/260
17	KU6909	Knives set in cover	



1



2



3



4



5



6



7



8



9

KITCHEN TOOLS

Ref.	Description
KU6652	1."y" Peeler, straight edge, Blade:5cmX1.5cm Length:16cm
KU6653	2."y" Peeler, serrated edge Blade:5cmX1.5cm Length:16cm
KU6654	3."y" Peeler, julienne edge Blade:5cmX1.5cm Length:16cm
KU6655	4.Straight peeler, straight edge Blade:5cmX1.5cm Length:19.5cm
KU6656	5.Straight peeler, serrated edge Blade:5cmX1.5cm Length:19.5cm
KU6661	6.Cheese Plane Blade:12cmX7.5cm Length:23.5cm
KU6663	7.Grater, Small holes Blade:14.5cmX5.5cm Length:26cm
KU6664	8.Grater, Medium holes Blade:14.5cmX5.5cm Length:26cm
KU6665	9.Grater, Larger holes Blade:14.5cmX5.5cm Length:26cm

SERVING ACCESSORIES

1



2



3



4



5



No.	Item No.	Product name	L (mm)
1	KU6925	Perforated spoon	310
2	KU6926	Serving fork	300
3	KU6927	Serving spoon	315
4	KU6928	Serving spatula	315
5	KU6929	Ladle	310



811 SERIES KITCHEN UTENSILS

- Polypropylene handle
- Available in black and white color

811FT01	1.Flexible turner, 11 x 9cm
811FT02	2.Flexible turner, 20 x 8cm
811FT03	3.Flexible turner, 20 x 8cm
811PS	4.Pie server, 13 x 6.5cm
811ST01	5.Square turner, 15 x 12.5cm
811HT	6.Hamburger turner, 13 x 8cm
811ST02	7.Square turner, 15 x 8cm
811C4	8.Pizza cutter, dia.10cm
811C25	9.Pizza cutter, dia.6.5cm
811C25D	10.Pizza cutter, double wheels, dia.6.5cm
811SS	11.Sandwich spreader, 10 x 2.5cm
811CSP06	12.Cranked spatula, 15cm
811CSP08	13.Cranked spatula, 20.5cm
811CSP10	14.Cranked spatula, 25.5cm

● Black(K) ○ White(W)

- Above items are available in black and white color

- Above sizes are circulated by blade dimension

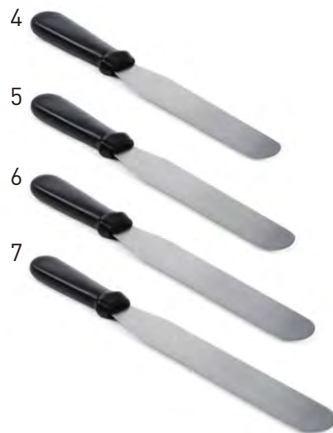

811SC04	1.Scraper, 14 x 10cm
811SC05	2.Scraper, 14 x 13cm
811SC06	3.Scraper, 16 x 14cm
811SP06	4.Spatula, 15cm / 6inch
811SP08	5.Spatula, 20cm / 8inch
811SP10	6.Spatula, 25cm / 10inch
811SP12	7.Spatula, 30cm / 12inch
811DS36	8.Dough scraper, 3 x 6inch
811DS37	9.Dough scraper, 3 x 7inch

461 Series Kitchen Utensils



Heavy Duty Ladles

- 4612LA 7cl/2.5oz/Dia.6.5cm
- 4613LA 12cl/4oz/Dia.8cm
- 4614LA 20cl/7oz/Dia.9cm
- 4615LA 25cl/8oz/Dia.10cm
- 4617LA 50cl/16oz/Dia.12cm
- 4618LA 70cl/25oz/Dia.14cm
- 4619LA 100cl/35oz/Dia.16cm



Skimmers

- 46108SM Dia.8cm
- 46110SM Dia.10cm
- 46112SM Dia.12cm
- 46114SM Dia.14cm
- 46116SM Dia.16cm
- 46118SM Dia.18cm
- 46120SM Dia.20cm



Turners

- 46118T 46cm/18"



Turners with holes

- 46118TH 46cm/18"



Slotted Spoon

- 461PA 46cm/18"



Solid Spoon

- 461PB 46cm/18"



Meat Fork

- 461MF 46cm/18"



Hanger with hook 6 pcs

- KU6627 38CM



613 Series Utensils

61310	1. Potato masher, 36cm/14"
61320	2. Ladle, 38.5cm/15"
61330	3. Spaghetti server, 38cm/15"
61340	4. Skimmer, 37.5cm/15"
61350	5. Solid spoon, 39cm/15.5"
61360	6. Slotted spoon, 39cm/15.5"
61370	7. Slotted turner, 43cm/17"
61380	8. Meat fork, 41cm/16"



712 Series Silicone

71201	1. Solid spoon, 36.5cm/14"
71202	2. Slotted spoon, 36.5cm/14"
71203	3. Slotted turner, 36.5cm/14"
71204	4. Rice spoon, 28cm/11"
71205	5. Masher, 28cm/11"
71206	6. Chinese turner, 36.5cm/14"
71207	7. Ladle, 33.5cm/13"
71208	8. Spaghetti server, 33.5cm/13"
71209	9. Skimmer, 38cm/15"
71210	10. Meat fork, 36.5cm/14"

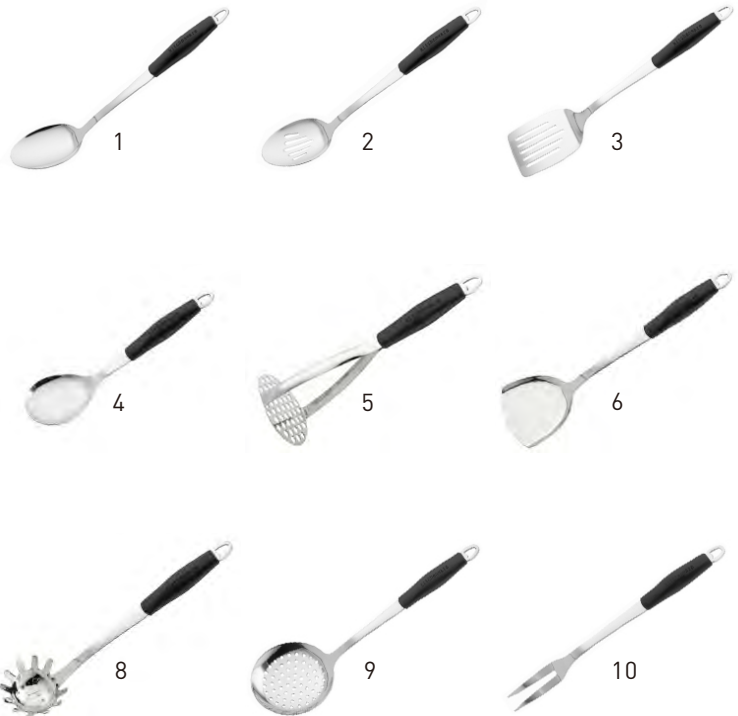

Whisks Stainless Steel

12-Wire Piano Whisks No Hooked Handle

M1225	25cm / 10"
M1230	30cm / 12"
M1235	35cm / 14"
M1240	40cm / 16"
M1245	45cm / 18"
M1250	50cm / 20"
M1255	55cm / 22"
M1260	60cm / 24"

Option: with hooked handle

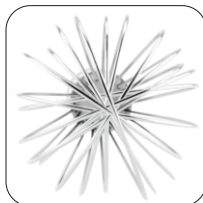

Hooked Handle

8-Wire French Whisks No Hooked Handle

M0825	25cm / 10"
M0830	30cm / 12"
M0835	35cm / 14"
M0840	40cm / 16"
M0845	45cm / 18"
M0850	50cm / 20"
M0855	55cm / 22"
M0860	60cm / 24"

Option: with hooked handle

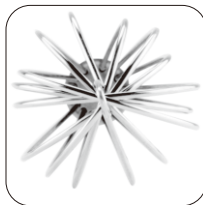

Hooked Handle

12-Piano Whisks with PP Handle

- Polypropylene handle with eyelet.
- Wire thickness: 1,4 mm

M1224P	24cm
M1226P	26cm
M1230P	30cm
M1234P	34cm
M1240P	40cm
M1244P	44cm





POTATO MASHERS

Item No.	mm
KU6945	ø118x(H)306
KU6946	ø118x(H)456



POTATO MASHERS

Item No.	mm
KU6947	200x130x(H)610
KU6948	200x130x(H)810

POTATO RICER

Item No.	mm
515105	300x110

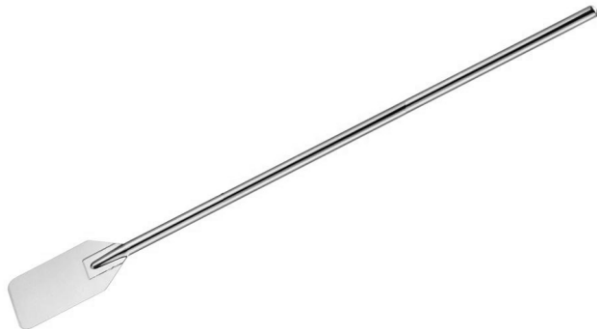

Mixing Stir Bar for stock pot

Item No.	mm	Inch"
MST060	115x(L)600	24"
MST076	115x(L)760	30"
MST091	115x(L)910	36"
MST100	115x(L)1000	42"
MST120	115x(L)1200	48"
MST130	115x(L)1300	54"
MST150	115x(L)1500	60"

Colander, Heavy Duty

Item No.	mm
CHD32	Φ320 & 200x(H)180
CHD36	Φ360 & 230x(H)200
CHD40	Φ400 & 260x(H)220
CHD45	Φ450 & 290x(H)240
CHD50	Φ500 & 330x(H)260
CHD55	Φ550 & 350x(H)300
CHD60	Φ600 & 400x(H)320



Stockpot Dolly Stainless Steel

Item No.	mm
CART-42	Dia.420x(H)130
CART-47	Dia.470x(H)130
CART-52	Dia.520x(H)130
CART-57	Dia.570x(H)130
CART-62	Dia.620x(H)130



Bucket without Lid

Item No.	mm	Capacity (liter)
BKT3008A	Φ250x(H)250	8L
BKT3014A	Φ300x(H)300	14L
BKT3020A	Φ350x(H)300	20L



OPTION: WITH LID



Bucket without Lid

Item No.	mm	Capacity (liter)
BKT3008	Φ250x(H)250	8L
BKT3014	Φ300x(H)300	14L
BKT3020	Φ350x(H)300	20L



OPTION: WITH LID





Colander, Heavy Duty

Item No.	mm
KU6739	Φ320 & 200x(H)180
KU6740	Φ360 & 230x(H)200
KU6741	Φ400 & 260x(H)220
KU6742	Φ450 & 290x(H)240
KU6743	Φ500 & 330x(H)260
KU6744	Φ550 & 350x(H)300
KU6745	Φ600 & 400x(H)320



Colander

Item No.	mm
CW1106	Dia.240x(H)110
CW1107	Dia.280x(H)175



Stainless steel sieve

Item No.	mm	Hole
CW1118	Dia 200×H70	20/30/50
CW1119	Dia 240×H70	20/30/50
CW1120	Dia 270×H70	20/30/50
CW1121	Dia 300×H70	20/30/50











Stainless steel sifter

Item No.	mm
CW1122	Φ80x(H)85
CW1123	Φ95x(H)130
CW1124	Φ120x(H)130

Dispenser Bottles Polyethylene

- The cap helps the sauce stay fresh and maintains hygiene

Item No.	color	mm
DB50Y		
DB50R		8oz, Dia.50x185mm
DB50W		
DB55Y		
DB55R		12oz, Dia.55x205mm
DB55W		
DB70Y		
DB70R		24oz, Dia.70x250mm
DB70W		



Confectionery Funnel & Stand

- Made of 18/10

Item No.	mm
F13106	Dia.190 x (H)220, 1.5L



Pancake Batter Dispenser

- Made of 18/10

Item No.	mm
F13105	145 x 155 x (H)105



Confectionery Funnel & Stand

- Made of 18/10

Item No.	mm
F13104	265 x 265 x (H)285



Conical Strainer, wire mesh

Item No.	mm
CW1112	Φ80
CW1113	Φ100
CW1114	Φ120
CW1115	Φ140
CW1116	Φ160
CW1117	Φ180



Conical Strainer, wire mesh

Item No.	mm
CW1108	Dia.160
CW1109	Dia.180
CW1110	Dia.200
CW1111	Dia.250



Conical Strainer, Half wire mesh

Item No.	mm
CW1104	Dia.200
CW1105	Dia.250



Conical Strainer

Item No.	mm
CW1101	Dia.180
CW1102	Dia.200
CW1103	Dia.250





High Heat Spatula

-Silicone head + ABS handle

Item No.	mm
S001	10" inch
S002	14" inch
S003	16" inch



High Heat Spoonula

-Silicone head + ABS handle

Item No.	mm
S004	10" inch
S005	14" inch
S006	16" inch



Spatula

-TRP head + ABS handle

Item No.	mm
S007	10" inch
S008	14" inch
S009	16" inch



Spoonula

-TRP head + ABS handle

Item No.	mm
S094	10" inch
S095	14" inch
S096	16" inch



High Heat Spatula

-Rubber + inside SS201

Item No.	mm
KU6769	270x54mm
KU6770	345x60mm
KU6771	400x70mm

Rolling Pin

-Stainless steel

Item No.	mm
RP065S	Dia.65x 250/470



Non-stick Rolling Pin

-Stainless steel

Item No.	mm
NRP065S	Dia.65x 250/470



Rolling Pin

-Wooden

Item No.	mm
RP075	Dia.75x 380/590



Dough cutter with scale

-Stainless steel

Item No.	mm
PB4421	L148 x W115

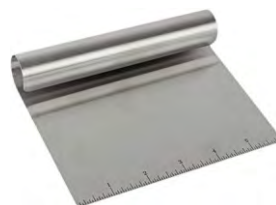



black available

Ice cream scoops

-Aluminum

Item No.	mm
PB4401	1.0oz
PB4402	1.5oz
PB4403	2.0oz
PB4404	2.5oz



Ice cream scoops

-Stainless steel

Item No.	mm
PB4405	Dia.45
PB4406	Dia.50
PB4407	Dia.55



Ice cream scoops

-Stainless steel

Item No.	mm
PB4408	Dia.45
PB4409	Dia.50
PB4410	Dia.55



Stand for 4 pcs ice cream waffle

-Stainless steel

Item No.	mm
PB4411	95x270xH85



KU6971



KU6972

PASTRY CUTTER SET

- 14-piece set, round model

- stainless steel 430

Item No. mm

KU6971 with plain edge, ø19-112,
ø120x(H)35

PASTRY CUTTER SET

- 14-piece set, round model

- stainless steel 430

Item No. mm

KU6972 with serrated edge, ø18-108,
ø120x(H)35

Pastry cutter set 12 pcs

-Stainless steel 304

Item No.	mm	
PB4428	Dia26-113 mm	Height: 30 mm



Square form

-Stainless steel

Item No.		mm
PB4433	□	3pcs 60/80/100
PB4434	△	3pcs 60/80/100
PB4435	○	3pcs 60/80/100



Puff Nozzle

-Stainless steel

Item No.	mm
PB4439	Dia.18xH76
PB4440	Dia.25xH93



Expanding pastry cutter 5 knives

-Stainless steel

Item No.	mm
PB4424	L280- 500



Rotating cake stand

PB4441 Dia 31 x 9 cm



Scraper

PB4429 125x97 mm
PB4430 155x107 mm



Nozzle 26 psc set

Pb4438 26pcs



Scraper

PB4431 193x127 mm



Icing bags and nozzles wall rack

Pb4436 L590xH580mm



Scraper

PB4432 158x103 mm



Tube brush

Pb4437 120mm



Dough container

- Temperature -40-70°C

Pb4455 650x450x45mm
Pb4456 650x450x80mm
Pb4457 650x450x150mm
Pb4458 Lid 670x455x20mm



Pizza screen

PB4444 Dia.230mm
PB4445 Dia.280mm
PB4446 Dia.310mm
PB4447 Dia.330mm
PB4448 Dia.360mm
PB4449 Dia.400mm
PB4450 Dia.460mm
PB4451 Dia.500mm



Display for sandwiches

PB4412 22x10x5 cm, 3pcs
PB4413 27x10x5 cm, 4pcs
PB4414 35x10x5 cm, 5pcs



ALUMINIUM BAKING PANS



BAKEWELL PAN

Item No.	mm	T (mm)
AB1201	318x220x(H)20	1.3
AB1401	370x270x(H)20	1.3
AB1701	425x310x(H)20	1.6
AB1901	475x360x(H)20	1.6
AB2101	530x430x(H)20	1.6
AB2401	615x468x(H)20	1.6



ROASTING DISH

Item No.	mm	T (mm)
AB1204	318x220x(H)70	1.3
AB1404	370x270x(H)70	1.3
AB1704	425x310x(H)70	1.6
AB1904	475x360x(H)70	1.6
AB2104	530x430x(H)70	1.6
AB2404	615x468x(H)70	1.6



BAKEWELL PAN

Item No.	mm	T (mm)
AB1202	318x220x(H)38	1.3
AB1402	370x270x(H)38	1.3
AB1702	425x310x(H)38	1.6
AB1902	475x360x(H)38	1.6
AB2102	530x430x(H)38	1.6
AB2402	615x468x(H)38	1.6



DEEP ROASTING DISH

Item No.	mm	T (mm)
AB1205	318x220x(H)90	1.3
AB1405	370x270x(H)90	1.3
AB1705	425x310x(H)100	1.6
AB1905	475x360x(H)100	1.6
AB2105	530x430x(H)100	1.6
AB2405	615x468x(H)100	1.6



BAKING PAN

Item No.	mm	T (mm)
AB1203	318x220x(H)70	1.3
AB1403	370x270x(H)70	1.3
AB1703	425x310x(H)70	1.6
AB1903	475x360x(H)70	1.6
AB2103	530x430x(H)70	1.6
AB2403	615x468x(H)70	1.6



EXTRA DEEP ROASTING DISH

Item No.	mm	T (mm)
AB1706	425x310x(H)150	1.6
AB1906	475x360x(H)150	1.6
AB2106	530x430x(H)150	1.6
AB2406	615x468x(H)150	1.6

Silicone pastry brush

PB4417 17.5x 3.2cm



Measuring cups

PB4415 1.25 / 2.5 / 5 / 15ml



Wooden pastry brush

PB4419 Width: 50mm
PB4420 Width: 75mm



Measuring cups

PB4416 60 / 80 / 125 / 250ml



Cutting roller

PB4425 70x195mm



Pizza shovel

PB4452 W22.5 x L58cm
PB4453 W30 x L91cm



Cutting roller

PB4426 125x215mm



Baking mat

-Temperature 40-250°C

PB4423 60x40cm
PB4459 42x29.5cm



Oven Cleaning Brush

PB4454 L930X260mm



Funnel

KU6601 Dia.10cm
KU6602 Dia.12cm
KU6603 Dia.14cm



Gater

KU6604 8" inch
KU6605 9" inch



Tweezers for fish bones

KU6626 W70x108 mm



Gater

KU6606 9" inch



Fish scaler

KU6607 L235 mm



Parmesan grater

KU6608 W60xL247mm



Fruit stand

PB4442 Dia.38x H 28cm



Fruit stand

PB4443 28.5x28.5x20.5cm



French fries scoop

KU6621 1 handle, 230 mm
KU6650 2 handles, 230 mm



Salad spinner

KU6624 Dia 465x565mm
KU6625 Dia 400x470mm



Garlic Press

KU6623 Depth: 185 mm



Measuring jug

KU6628 0.5L
KU6629 1.0L
KU6630 2.0L



Garlic Press

KU6651 Depth: 187 mm



PP measuring jug

KU6631 0.5L
KU6632 1.0L
KU6633 2.0L
KU6634 3.0L
KU6635 5.0L



Scoop Aluminum

555 001 153x50x30mm
555 002 180x55x33mm



Scoop Aluminum

555 003 190mm/ 6oz
555 004 220mm/ 12oz
555 005 290mm/ 24oz
555 006 310mm/ 38oz
555 007 370mm/ 58oz



Scoops

KU6636 W5.8xL23cm
KU6637 W7.5xL26cm
KU6638 W10xL30cm



Scoops

KU6639 W6.5xL21cm
KU6640 W8.0xL24cm
KU6641 W9.5xL26cm



Hat pin for tickets

KU6642 Dia 8 x H 15cm



Reception desk bell

KU6643 Dia 8.5 x H6 cm



Table top can opener

KU6666 H 640 mm



Digital scale 5kg/0.1g

KU6645 198x141x31mm

PS:
1. ABS housing with dia 133mm SS tray;
2. Suitable for two AAA size batteries



Kitchen scale 15 KG

KU6647 243x168x33 mm
Suitable for two AAA size batteries



Scale 2 KG

KU6646 21.8x21x25mm
Including Ø 200 mm bowl





**OIL-RESISTANT THERMAL GLOVES
FOR BBQ**

- made of neoprene

KU6636 up to 100 °C



OVEN GLOVE HEAT RESISTANT

- Heat resistant up to 250 °C.
- Comfortable fit

KU6636 300mm



OVEN GLOVES

- fireproof impregnated cotton
- 2-finger

KU6636 300mm, up to 230 °C



OVEN MITTS LEATHER

- Made from cow leather.
- Extra long to protect the forearm

KU6636 460mm, up to 250°C.



Oven mitts

PB4422 Temperature min: 230 °C
L35 x W16 cm 1 pair



c a t e r i n g

TABLEWARE





10 Series Flatware set

- Stainless steel 18/0

-
- | | |
|--------|----------------------------------|
| TW7823 | 1. Table Knife, L 224, T 5.0mm |
| TW7824 | 2. Table Spoon, L 200, T 2.0mm |
| TW7825 | 3. Table Fork, L 200, T 2.0mm |
| TW7826 | 4. Dessert Spoon, L 137, T 2.0mm |

20 Series Flatware set

- Stainless steel 18/8

-
- | | |
|--------|----------------------------------|
| TW7827 | 1. Table Knife, L 224, T 5.0mm |
| TW7828 | 2. Table Spoon, L 200, T 2.0mm |
| TW7829 | 3. Table Fork, L 200, T 2.0mm |
| TW7830 | 4. Dessert Spoon, L 137, T 2.0mm |



30 Series Flatware set

- Knife in stainless steel 420, others in SUS304

TW7831 1. Table Knife, L 217 , T 7.0mm

TW7832 2. Table Spoon, L 196 , T 3.0mm

TW7833 3. Table Fork, L 197 , T 3.0mm

TW7834 4. Dessert Spoon, L 153 , T 2.0mm

TW7835 5. Cake Fork, L 155 , T 2.0mm

TW7836 6. Tea Spoon, L 112 , T 2.0mm

TW7837 7. Dessert Knife, L 172 , T 6.0mm

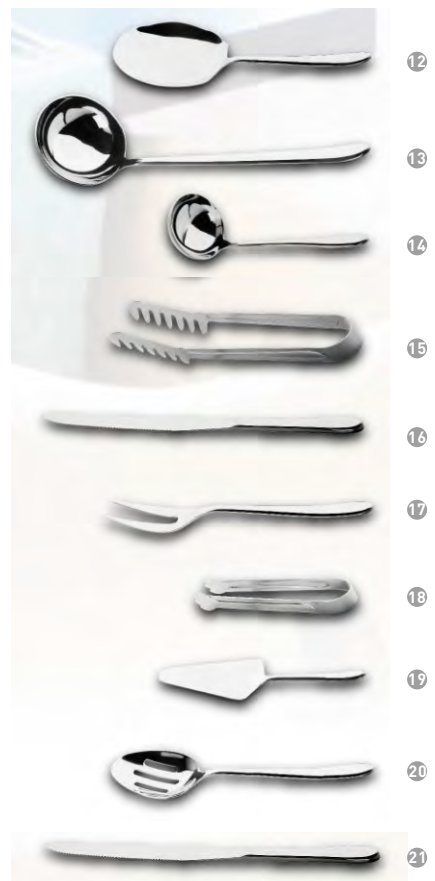

50 Series Cutlery set

- Knife in stainless steel 420, others in SUS304

TW7838	1. Table Knife, L 228 , T 7.0mm	TW7849	12. Rice Server, L , T 3.0mm
TW7839	2. Table Spoon, L 197 , T 3.0mm	TW7850	13. Soup Ladle, L , T 3.0mm
TW7840	3. Table Fork, L 208 , T 3.0mm	TW7851	14. Gravy Ladle, L , T 3.0mm
TW7841	4. Dessert Spoon, L 143 , T 2.0mm	TW7852	15. Salad Tong, L , T 1.5mm
TW7842	5. Cake Fork, L 145 , T 2.0mm	TW7853	16. Serving Knife, L , T 7.0mm
TW7843	6. Coffee Spoon, L , T 2.0mm	TW7854	17. Serving Fork, L , T 3.0mm
TW7844	7. Soda Spoon, L 208 , T 2.0mm	TW7855	18. Ice Tong, L , T 1.2mm
TW7845	8. Fruit Knife, L 175 , T 6.0mm	TW7856	19. Cake Server, L , T 3.0mm
TW7846	9. Butter Knife, L , T 2.0mm	TW7857	20. Slotted Spoon, L , T 3.0mm
TW7847	10. Honey Spoon, L , T 2.0mm	TW7858	21. Steak Knife, L , T 7.0mm
TW7848	11. Big Serving Spoon, L , T 3.0mm		

Enamelware



1



2



3



4



5



6

No.	Item No.	Product name	L (mm)
1	TW7869	Flat Plate	Φ200x15
	TW7870	Flat Plate	Φ240x20
2	TW7871	Deep Plate	Φ220x45
3	TW7873	Platter	180x130x40
	TW7874	Platter	200x145x43
	TW7875	Platter	220x170x47

No.	Item No.	Product name	L (mm)
4	TW7872	Salad-Bowl	Φ160x65
5	TW7877	Mug	Φ80x80
	TW7878	Mug	Φ90x90
	TW7879	EspreSSo Cup	Φ50x50
6	TW7876	Mug Without Lug	Φ90x90

Slate Plateaus

TW7730 Dia 250x(H)5mm

TW7731 Dia 300x(H)5mm

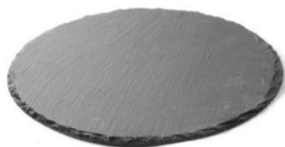

Slate Plateaus

TW7732 200x200x(H)5mm

TW7733 250x250x(H)5mm

TW7734 300x300x(H)5mm

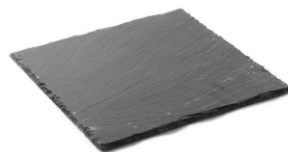

Slate Plateaus

TW7735 200x100x(H)5mm

TW7736 300x100x(H)5mm



Slate Plateaus

TW7737 325x265x(H)5mm

TW7738 325x176x(H)5mm

TW7739 265x162x(H)5mm



Slate Plateaus

TW7740 300x450x(H)40mm



Slate Plateaus

TW7741 200x100x(H)5mm

TW7742 300x150x(H)5mm



Snack Pan

TW7809 185x95x(H)45mm



Bucket Mini

TW7810 Dia 70x(H)77mm

TW7811 Dia 130x(H)130mm



Tabletop Blackboard

TW7762 150x50x(H)230mm

TW7763 210x50x(H)320mm



Tabletop Blackboard

TW7775 148x130x(H)120mm

TW7776 210x190x(H)150mm





1



2



3



4



5



6



7



8

1.CONDIMENT SET

- 2 piece salt, pepper
- Matt finish

Item No.	mm
TW7859	85x55x(H)115

2.CONDIMENT SET

- 3 piece salt, pepper, napkin holder
- Matt finish

Item No.	mm
TW7860	85x75x(H)115

3.CONDIMENT SET

- 2 piece oil, vinegar
- Matt finish

Item No.	mm
TW7861	120x75x(H)185

4.CONDIMENT SET

- 4 piece salt, pepper, oil, vinegar
- Matt finish

Item No.	mm
TW7862	130x110x(H)185

5.CONDIMENT SET

- 3 piece salt, pepper, toothpick holder
- Matt finish

Item No.	mm
TW7863	90x90x(H)115

6.CONDIMENT SET

- 3-piece salt, pepper, mustard
- With stainless steel mustard spoon
- Matt finish

Item No.	mm
TW7864	100x95x(H)115

7.CONDIMENT SET

- 5 piece salt, pepper, oil, vinegar, toothpick holder
- Matt finish

Item No.	mm
TW7865	130x110x(H)185

8.CHEESE/SUGAR DISH

- with glass dish
- including stainless steel spoon

Item No.	mm
TW7866	Dia.130x(H)90

Steak Fork

Tw7816

220mm



Steak knife

Tw7817

220mm



Snail Dish

Tw7705 165x195xH20mm, 6 snails

Tw7706 215x245xH20mm, 12 snails



Snail Tong

Tw7707

170mm



Snail Fork

Tw7709

125mm



Snail Tong

Tw7708

160mm



Lobster Fork

Tw7710

165mm



Chrome-Plated Lobster Tong

Tw7711

153x33mm



Walnut Cracker

Tw7712

170x45mm



Walnut Cracker

Tw7713

140x53mm



Shaker

TW7866 40x40x90mm



Shaker High Model

TW7807 Dia 45x(H)110mm
30ML



Shaker

555 009 Dia 50 x 80mm, hole 1.5mm
555 010 Dia 50 x 80mm, bet-like
555 011 Dia 50 x 80mm, hole 2.2mm



Shaker

TW7808 Dia 50 x H60 mm



Olive Oil Pitcher

KW7867 H157 mm, 0.26L



Olive Oil Pitcher

KW7868 H157 mm, 0.26L



Wooden Salt/Pepper Grinder

TW7801 Dia 58x200mm
TW7802 Dia 68x300mm
TW7803 Dia 68x400mm



Acrylic Salt/Pepper Grinder

TW7798 Dia.55 x 140mm / 5" inch
TW7799 Dia.55 x 160mm / 6" inch
TW7800 Dia.55 x 200mm / 8" inch



Bread Bin

555 008 44x25x17cm



Table Cloth Clip

Tw7791 65 x 50mm



Bread Basket

Tw7743 232 x 178 x 50mm
Tw7744 230 x 150 x 65mm
Tw7745 375 x 150 x 70mm



Bread Basket

Tw7746 Dia.240 x 50 mm



Bread Basket

Tw7747 235x150x H70mm
Tw7748 380x270x H90mm



Bread Basket

Tw7749 GN 1/1 x H 70mm



Bread Basket

wire frame

Tw7756 GN1/1 x 80mm
Tw7757 GN1/2 x 80mm
Tw7758 GN1/3x 80mm
Tw7759 GN1/4x 80mm
Tw7760 GN1/6 x 80mm
Tw7761 GN2/3 x 80mm



Ice Cream Cup

Tw7714 Dia.105x H65



Sauce Cup

Tw7718 65x H48mm
Tw7719 78x H35mm
Tw7720 100x H51mm
Tw7721 105x H70mm



Gravy Boat

Tw7715 175 x78 H 70mm, 4 oz
Tw7716 213 x92 H 84mm, 8 oz
Tw7717 227 x97 H 92mm, 10 oz



Serving Dish

Tw7722 200x100x20mm



Butter Dish - With Lid

555 036 125x(H)55mm



Egg Cup

Tw7725 dia 48xH45mm



Sugar Bowl

Tw7777 Dia. 75 x 70 mm
Tw7778 Dia. 85 x 80 mm
Tw7779 Dia. 85 x 65 mm



Egg Cup

Tw7726 dia 85x(H)22mm



Tabletop bin

Tw7727 dia 120x(H)165mm



Ashtray With Lower Tray

555 025 dia 160x(H)30mm



Ashtray Profi Line

555 020 dia 80x H30mm
555 022 dia 100x H30mm
555 023 dia 120x H30mm



Table Sign

Tw7792 100x70mm



Ash Collector

555 020 210x140x90mm



Door sign / wall sign

Tw7793 Dia. 75mm
Tw7795 Dia. 160mm



Napkin Holder

Tw7796 170x30x(H)70mm





1



2



4



3



5

1. Wall Blackboard

TW7764	300x400 mm
TW7765	400x600 mm
TW7766	600x800 mm

2. Pavement Blackboard

TW7767	500x450x(H)850mm
TW7768	700x600x(H)1200mm

5. Pavement Blackboard w/ Steel Frame

TW7774	500x550x(H)850mm
--------	------------------

3. Pavement Blackboard w/ Steel Frame

TW7772	700x500x(H)1100mm
--------	-------------------

4. Blackboard With Easel

TW7773	220x210x(H)360mm
--------	------------------



c a t e r i n g

BUFFET WARE



HEATING LAMPS FOR DISHES

- Keep food warm
- Perfectly for restaurants, hotel etc

Hanging Heat Lamp

- dia250, Flexible:600-1500mm
- power: 220V/275W

Item No.	Description
BFL42	
BFL44	
BFL46	



Heat Lamp with Round Stand



- 220V/275W

Item No.	Description	mm
BFL36		270X645
BFL38		270X645



Hanging Heat Lamp Food Warmer

- 220V/275W

Item No.	Description	mm
BFL28		dia190, Flexible:600-1500mm
BFL30		dia190, Flexible:600-1500mm

Heat Lamp with U Shape Stand



- 220V/275W

Item No.	mm
BFL40	500x300x700



Hanging Heat Lamp

- Power: 220V/275W

Item No.	Description	mm
BFL48		dia290, Flexible:600-1500mm
BFL50		dia290, Flexible:600-1500mm
BFL52		dia290, Flexible:600-1500mm



It can be fitted
2* food pan 1/2
or 3* food pan 1/3



Item No.	Model	cm
9011	GN1/1 set w/burner-9L	56x40x(H)32
9023	GN2/3 set w/burner-6L	40x39x(H)32
9012	GN1/2 set w/burner-4L	36x34x(H)32



It can be fitted
2* food pan 1/2
or 3* food pan 1/3



Item No.	Model	cm
8011	GN1/1 set w/burner-9L	57x43x(H)29
8023	GN2/3 set w/burner-6L	43x39x(H)29
8012	GN1/2 set w/burner-4L	37x36x(H)29



6L



10L

Item No.	Model	cm
8006L	Round Chafer set w/burner-6L	47x42x(H)32
8010L	Soup Station set w/burner-10L	42x42x(H)38

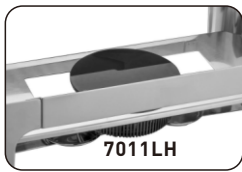

7011LH



7011U



Burner holder



HL-C10K



7011L

It can be fitted
2* food pan 1/2
or 3* food pan 1/3

Item No.	Model	cm
7011L	GN1/1 set w/burner-9L	59x41x(H)33
7011LH	GN1/1 set w/Induction heating-9L	59x41x(H)33
7011U	GN1/1-9L(upper part)	59x41x(H)20
HL-C10K	Induction heating 1KW/220V	



Heater
installation
handles



Stay at
90° or 180°



Burner holder



ICW700



Item No.	Model	cm
723	GN1/1 set w/burner-9L	64x49.5x(H)44
723H	GN1/1 set w/Induction heating-9L	64x49.5x(H)44
ICW700	Induction heating 700W/220V	20x(H)30



Show
window
option



Heater
installation
handles



Stay at
90° or 180°



Burner holder



ICW700



Item No.	Model	cm
721	Round roll top set w/burner-6L	47.5x52x(H)46.5
721H	Round set w/Induction heating-6L	47.5x52x(H)46.5
ICW700	Induction heating 700W/220V	



1011L

It can be fitted
2* food pan 1/2
or 3* food pan 1/3



1011LH



1011U



Burner holder



HL-C10K

Item No.	Model	cm
1011L	GN1/1 set w/burner-9L	59x46x(H)33
1011LH	GN1/1 set w/Induction heating-9L	59x46x(H)33
1011U	GN1/1-9L(upper part)	58.5x45.5x(H)21
HL-C10K	Induction heating 1KW/220V	



1060L



1060LH



1060U



Burner holder



HL-C10K

Item No.	Model	cm
1060L	Round set w/burner-6L	52x46x(H)33
1060LH	Round set w/Induction heating-6L	52x46x(H)33
1060U	Round-6L(upper part)	52x45.5x(H)21
HL-C10K	Induction heating 1KW/220V	



10-11L



10-11LH



10-11U



Burner holder



HL-C10K

Item No.	Model	cm
10-11L	Soup Station set w/burner-11L	50x47x(H)45
10-11LH	Soup Station set w/Induction heating-11L	50x47x(H)45
10-11U	Soup Station-11L(upper part)	49.5x47x(H)32.5
HL-C10K	Induction heating 1KW/220V	



2011LH



2011U



Burner holder



HL-C10K

Item No.	Model	cm
2011L	GN1/1 set w/burner-9L	66x49x(H)33
2011LH	GN1/1 set w/Induction heating-9L	66x49x(H)33
2011U	GN1/1-9L(upper part)	57x46.5x(H)16
HL-C10K	Induction heating 1KW/220V	



2011L

It can be fitted
2* food pan 1/2
or 3* food pan 1/3



2060LH



2060U



Burner holder



HL-C10K

Item No.	Model	cm
2060L	Round set w/burner-6L	45x55x(H)33
2060LH	Round set w/Induction heating-6L	45x55x(H)33
2060U	Round-6L(upper part)	50x45x(H)16
HL-C10K	Induction heating 1KW/220V	



2060L



20-11LH



20-11U



Burner holder



HL-C10K

Item No.	Model	cm
20-11L	Soup Station w/burner-11L	46x42x(H)33
20-11LH	Soup Station w/Induction heating-11L	46x42x(H)33
20-11U	Soup Station-11L(upper part)	46x41.5x(H)25.5
HL-C10K	Induction heating 1KW/220V	



20-11L



It can be fitted
2* food pan 1/2
or 3* food pan 1/3



Stackable design



Burner holder

Item No.	Model	cm
633	GN1/1 set w/burner-9L	60x35x(H)32



It can be fitted
2* food pan 1/2
or 3* food pan 1/3



Foldable design



Burner holder

Item No.	Model	cm
533	GN1/1 set w/burner-9L	57x35x(H)31.5



It can be fitted
2* food pan 1/2
or 3* food pan 1/3



Stackable design



Burner holder

Item No.	Model	cm
833	GN1/1 set w/burner-9L	64x35x(H)32



Item No.	Model	cm
633-30	GN1/1 set w/burner consists of 1*GN1/1x65mm 2*GN1/2x65mm 3*GN1/3x65mm	60x35x(H)32

Item No.	Model	cm
939	GN1/1 set w/burner-9L	65x37x(H)39
939H	GN1/1 set w/Induction heating-9L	65x37x(H)39
ICW700	Induction heating 700W/220V	20x(H)30



Burner holder



Soup Kettles



Item No.	Model	cm
638	GN1/1 set w/burner-9L	60x35x(H)35.5

Option: Induction heating



It can be fitted
2* food pan 1/2
or 3* food pan 1/3



Plug



Lid holder

Item No.	Model	cm
690	GN1/1 set w/heater-9L 230V, 900W	61.5x35.5x(H)28

Suitable for pans up to 100mm deep.



It can be fitted
2* food pan 1/2
or 3* food pan 1/3



Item No.	Model	cm
691	GN1/1 set w/heater-9L 230V, 900W	57.3x34.8x(H)28

Suitable for pans up to 100mm deep.



Item No.	Model	cm
SK10LB	Soup kettle 10L, black steel	Dia.34x(H)36
SK10LS	Soup kettle 10L, Stainless steel	Dia.34x(H)36



Lid



Burner holder



Item No.	Model	cm
834	GN1/2 set w/burner-4L	43x30x(H)32
831	GN1/3 set w/burner-2.5L	43.5x21x(H)31



7.5L



Burner holder



Item No.	Model	cm
832	Round set w/burner-5L	42x34x(H)30
835	Round set w/burner-7.5L	42x34x(H)33

Option: glass lid is available



For ladle



Burner holder



Item No.	Model	cm
8311	Round set w/burner-11L	36x29x(H)33



Ice in mid-hole



Faucet

Item No.	Model	cm
JD-8L	Juice Dispenser, 8L	27x36x(H)59
JD-16L	Juice Dispenser, 16L	58x36x(H)59



Drip tray



Faucet

Item No.	Model	cm
MD-8L	Milk Dispenser, 8L	27x36x(H)53
MD-16L	Milk Dispenser, 16L	58x36x(H)53



Burner holder



Faucet

Item No.	Model	cm
CU-13L	Coffee urn, 13L	26x32x(H)57

Item No.	Model	cm
10-12	S/S body for coffee	35x30x(H)49.5
10-12P	PC body for juice	35x30x(H)49.5



Item No.	Model	cm
20-12	S/S body for coffee	36x36x(H)46
20-12P	PC body for juice	36x36x(H)46



Item No.	Model	cm
Bf2250	Juice Dispenser 3L	21.5x31.5x(H)49





Cereal Dispenser, 3L

Item No.	Model	cm
BF2251	Cereal Dispenser, 3L	18.4x24x(H)60



Cereal Dispenser, 12L

Item No.	Model	cm
BF2252	Cereal Dispenser, 12L	23x18.6x(H)61.7



Cereal Dispenser, 9L

Item No.	Model	cm
BF2253	9L, for cereal dispenser	34.5x25x(H)66

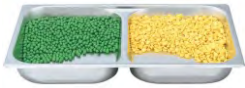

2-Compartment GN 1/1

	GN	mm
BF2234	1 / 1	65



Conversion

	GN	mm
BF2235	1 / 1	30



Round Food container for Chafer

	mm
BF2236	Dia.385xH65



Soup Bucket

	mm
BF2237	4QT, 190 x 190 x H 215
BF2238	7QT, 240 x 240 x H 215
BF2239	11QT, 290 x 290 x H 215
BF2237L	Lid for 4QT
BF2238L	Lid for 7QT
BF2239L	Lid for 11QT



2-Compartment Round Food Pan

	mm
BF2240	Dia.340x65
BF2241	Dia.385x65



Induction Heater 800W

	mm
BF2242	Dia.240xH68



Chafing Dish Heater for Underneath Water Pan

	mm
BF2243	400W 300x200



Mounting Frame for Induction Heater

	mm
BF2244	Dia.270xH17

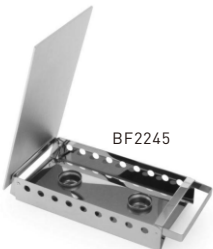

BF2245

Dish Warmer

	mm
BW2245	2 burner, 380 x 180 x H65
BW2246	3 burner, 450 x 180 x H65
BW2247	Dia46, burner



BF2247



Spoon Holder (Holder Only)

	mm
BF2248	110 x 264



Buffet Utensils

Ref.	Description
BF2201	1.Slotted serving spoon, 293x62mm
BF2202	2.Solid serving spoon, 298x62mm
BF2203	3.Notched serving spoon, 293x62mm
BF2204	4.Ladle 4oz, 312x92mm
BF2205	5.Cake server, 270x54mm
BF2206	6.Ladle with spout 2oz, 312x106mm
BF2207	7.Ladle with spout 1oz, 302x86mm
BF2208	8.Serrated bread knife, 345x21mm
BF2209	9.Fork 2 tine, 283x 2mm
BF2210	10.Fork 4 tine, 265x45mm
BF2211	11.Slotted turner, 370x80mm
BF2212	12.Skimmer, 360xDia.114mm
BF2213	13.Pie server, 315x98mm

Tongs



1 Universal Tong

Code	L (mm)
TONG3110	250mm
TONG3112	300mm
TONG3114	350mm
TONG3116	400mm

4 PC Tong

Code		L (mm)
BF2216	Black	230mm
BF2217	Transparent	230mm

7 Grill Tong

Code	L (mm)
BF2220	220mm
BF2221	280mm

2 Universal Tong

Code	L (mm)
TONG2210	250mm
TONG2212	300mm
TONG2214	350mm
TONG2216	400mm

5 Ice Cube Tong

Code	L (mm)
BF2218	180mm

8 Pastry Tong

Code	L (mm)
BF2222	220mm
BF2223	280mm

3 Universal Tong

Code	L (mm)
TONG5110	240mm
TONG5112	300mm
TONG5116	400mm

6 Pom Tong

Code	L (mm)
BF2219	150mm

9 Pastry Tong

Code	L (mm)
BF2224	280mm

Tongs



1



2



3



4



5



6



7



8



9

1 Cake Tongs

Code	L (mm)
BF2225	225mm

4 Salad Tongs

Code	L (mm)
BF2229	240mm

7 Spaghetti Tongs

Code	L (mm)
BF2232	185mm

2 Scissor Salad Tongs

Code	L (mm)
BF2226	250mm

5 Cake Tongs

Code	L (mm)
BF2230	240mm

8 Sugar Cube Tongs

Code	L (mm)
BF2233	160mm

3 Tweezers

Code	L (mm)
BF2227	210mm
BF2228	300mm

6 Sandwich Tongs

Code	L (mm)
BF2231	150mm

9 Pasta Tongs

Code	L (mm)
BF2234	300mm

Vacuum Pots

CVP1000S	1.0ltr
CVP1500S	1.5ltr
CVP2000S	2.0ltr

Mirror or Satin polished



Mirror Satin

Vacuum Pots

MVP750S	0.75ltr
MVP1000S	1.0ltr
MVP1500S	1.5ltr
MVP2000S	2.0ltr

Mirror or satin polished



Vacuum Jugs, Push Button

C10005-1B	1.0ltr
C10005-2B	1.5ltr
C10005-3B	2.0ltr



Vacuum Jugs, Push Button

VP1-1B	1.0ltr
VP1-2B	1.5ltr
VP1-3B	2.0ltr



Vacuum Jugs, Push Button

VP4-1B	1.0ltr
VP4-2B	1.5ltr
VP4-3B	2.0ltr



Vacuum Jugs, Push Button

VP2-1B	1.0ltr
VP2-2B	1.5ltr
VP2-3B	2.0ltr



Vacuum Jugs, Push Button

VP3-1B	1.0ltr
VP3-2B	1.5ltr
VP3-3B	2.0ltr
VP3-4B	3.0ltr



Vacuum Airpot Pump

VAP-1B	4.0ltr
VAP-2B	3.5ltr
VAP-3B	3.0ltr
VAP-4B	2.5ltr





Stainless Steel Riser

Item No.	cm
SSR1203	12x12x(H)3
SSR1208	12x12x(H)8
SSR1212	12x12x(H)12
SSR1216	12x12x(H)16
SSR1224	12x12x(H)24
SSR1803	18x18x(H)3
SSR1812	18x18x(H)12
SSR1818	18x18x(H)18



NAT10



SLR0917

Item No.	Model	cm
NAT10	Name Tag	(H)10
NAT20	Name Tag	(H)20
SLR0917	Spoon/Ladle rest	9x(H)17



228006



228007



228004



Item No.	Model	cm
228006	Cutlery basket, 4 compartments	53x30x(H)10
228005	Cutlery basket with handle	43x25x(H)15
228004	Cutlery basket without handle	43x25x(H)15
228007	Cutlery single basket	11x11x(H)14

Cutlery Tray

Item No.	cm
BF2235	53x32.5x(H)10



Cutlery Tray

Item No.	cm
BF2236	53x32.5x(H)10.5



Cutlery Tray Stand

Item No.	Model	cm
BF2237	one layer	54x33x(H)28
BF2238	two layers	54x33x(H)54



Displays and Holder



1 Counter Display

Code	L (mm)
BF2239	510x230xH230 for 1/6 GN pans max depth 150mm

4 Counter Display

Code	L (mm)
BF2240	730x230xH230 for 3*1/6 GN pans and 2*1/9 GN pan

6 Flatware Cylinder

Code	L (mm)
CY000S	115x140xH85

2 Cylinder Holder w/ Cylinder

Code	L (mm)
CH204S	Stainless
CH204P	Plastic
Size: 305 x 260 x H216 mm	

5 Cylinder Holder w/ Cylinder

Code	L (mm)
CH306S	Stainless
CH306P	Plastic
Size: 380 x 260 x H216 mm	

7 Flatware Cylinder

Code	L (mm)
CY000P	115x140xH85

3 GN Container Holder

Code	L (mm)
CH506	980x250 xH210 fit 3*1/3 GN 150mm

Serving Trays



1 Tray GN1/1

Code	L (mm)
BF2241	10mm

4 Tray Rectangular

Code	L (mm)
BF2245	20mm

7 Round Tray

Code	L (mm)
BF2251	Dia.350x10
BF2252	Dia.400x15

2 Tray GN1/1

Code	L (mm)
BF2242	10mm

5 Tray Rectangular w/ Handle

Code	L (mm)
BF2246	20mm

8 Round Tray

Code	L (mm)
BF2253	Dia.350x10
BF2254	Dia.400x15

3 Tray GN1/1

Code	L (mm)
BF2243	20mm
BF2244	40mm

6 Square Tray

Code	L (mm)
BF2247	200x160x10
BF2248	300x160x10
BF2249	310x210x10
BF2250	420x280x6

9 Round Tray for plate

Code	L (mm)
BF2255	Dia.320x10

Serving Trays



1



4



7



2



5



8



3



6

1 Deep round tray

Code	L (mm)
BF2256	Dia.250x20
BF2257	Dia.295x25
BF2258	Dia.355x25
BF2259	Dia.415x30

4 Oval tray cover

Code	L (mm)
BF2272	187x132x25
BF2273	245x170x25
BF2274	290x200x30
BF2275	336x203x40
BF2276	453x290x50

7 Deep oval tray 2 divide

Code	L (mm)
BF2289	348x210x40
BF2290	508x310x50

2 Service tray oval

Code	L (mm)
BF2260	200x142x17
BF2261	225x160x17
BF2262	253x177x20
BF2263	300x220x28
BF2264	355x220x20
BF2265	400x260x20
BF2266	450x290x25
BF2267	500x350x28

5 Deep oval tray 2 divide

Code	L (mm)
BF2277	203x142x30
BF2278	254x180x40
BF2279	305x210x40
BF2280	348x210x40
BF2281	508x310x50

8 Deep oval tray 3 divide

Code	L (mm)
BF2291	348x210x40
BF2292	508x310x50

3 Oval tray

Code	L (mm)
BF2268	196x151x10
BF2269	230x175x10
BF2270	265x203x12
BF2271	295x225x13

6 Deep oval tray

Code	L (mm)
BF2282	172x120x29
BF2283	203x142x30
BF2284	224x162x38
BF2285	254x180x40
BF2286	300x210x40
BF2287	348x210x40
BF2288	508x310x50





1



2



3



4



5



6



7

1 Serving Tray Non-Slip

Code	L (mm)
BF2293	Dia.355
BF2294	Dia.410

2 Serving Tray Non-Slip

Code	L (mm)
99-63N	510x380
99-64N	445x355
99-65N	405x305
99-66N	355x255

3 Fiberglass tray Gn 1/1

Code	L (mm)
99-116	530x325

4 Fast Food Tray Eco

Code	L (mm)
9914	350x450
9913	300x400
9912	250x350

5 Square Tray

Code	L (mm)
BF2296	425x300x32

6 Pitcher 1.8L

Code	L (mm)
BF2297	Dia.120x350

7 Pitcher 2L

Code	L (mm)
BF2298	Dia.120x250





Coffee/Tea Pot

	liter
BF2256	0.40
BF2257	0.80
BF2258	1.40
BF2259	1.95



Milk Jug

	liter
555 021	0.35
555 022	0.60
555 023	0.90
555 024	1.50



Jug

	liter
BF2262	2.00



Milk/Cream Jug

	liter
BF2260	0.15
BF2261	0.25



Catering Thermos

	liter
BF2298	9.50
BF2299	14.0



Rectangle Cover Gn 1/1

	mm
BF2242	540x330x180



Cake Server

	mm
BF2241	260x60



Cake Presentation Cover

	mm
BF2243	Dia.300x110



Tray Cover

	mm
BF2246	Dia240xH57
BF2247	Dia265xH59
BF2248	Dia290xH61
BF2249	Dia315xH63



Aluminium Bill Holder

	mm
BH-12	360x60x20
BH-18	450x60x20
BH-24	600x60x20
BH-36	900x60x20
BH-40	1000X60X20
BH-48	1200X60X20

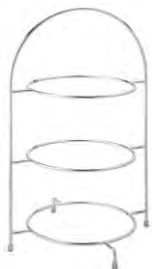

Serving Cake Stand For Plates

	mm
BF2245	273X225X425



Fruit Stand

	mm
BF2244	DIA 268/220/166 H320



1 Buffet Table Foldable

Code	L (mm)
BF2303	1830x750x(H)740, stronger
BF2304	1800x740x(H)740
BF2305	1520x700x(H)740

4 Catering Chair Foldable

Code	L (mm)
BF2308	540x440x(H)840

7 Buffet Table

Code	L (mm)
BF2344	1220x610x(H)740

2 Round Table Foldable

Code	L (mm)
BF2306	Dia. 1220 mm

5 Baby Chair

Code	L (mm)
BF2309	634x583xH768

8 Buffet Bench

Code	L (mm)
BF2345	1820x250xH435

3 Buffet Table Foldable

Code	L (mm)
BF2307	Dia. 800x(H)1100

6 Changing Table For Baby

Code	L (mm)
BF2310	850x540xH480



c a t e r i n g

HYGIENE



Rack Bases of Dishwasher

The base can be stackable and provide good washing results, good basket handling and a clean and safe storage.



Universal Base
500 x 500 x H100mm
Code No.228000



Base of cutlery
500 x 500 x H100mm
Code No.228001



Tray Base 25 Thorn
500 x 500 x H100mm
Code No.228002



Tray Base 64 Thorn
500 x 500 x H100mm
Code No.228003



Extender of universal base
500 x 500 x H45mm
Code No.228018



Cover of base,
Basket size
500 x 500 mm
Code No.228008



Dishwasher Basket Cart
550 x 550 x H850mm
Code No.: DBC-S



Dishwasher Basket Cart
540 x 600 x H880mm
Code No.: DBC-P



Extender with 9 comp.

500 x 500 x H45mm
Compartments 150 x 150 mm
Code No.228009



Extender with 16 comp.

500 x 500 x H45mm
Compartments 150 x 150 mm
Code No.228016



Base with 9 comp.

500 x 500 x H100mm
Compartments 150 x 150 mm
Code No.228109



Base with 16 comp.

500 x 500 x H100mm
Compartments 110 x 110 mm
Code No.228116



Extender with 20 comp.

500 x 500 x H45mm
Compartments 90 x 110 mm
Code No.228020



Extender with 25 comp.

500 x 500 x H45mm
Compartments 90 x 90 mm
Code No.228025



Base with 20 comp.

500 x 500 x H100mm
Compartments 90 x 110 mm
Code No.228120



Base with 25 comp.

500 x 500 x H100mm
Compartments 90 x 90 mm
Code No.228125



Extender with 36 comp.

500 x 500 x H45mm
Compartments 75 x 75 mm
Code No.228036



Extender with 49 comp.

500 x 500 x H45mm
Compartments 65 x 65 mm
Code No.228049



Base with 36 comp.

500 x 500 x H100mm
Compartments 75 x 75 mm
Code No.228136



Base with 49 comp.

500 x 500 x H100mm
Compartments 65 x 65 mm
Code No.228149

Wall Mounted Wash Basin

- Knee operated water outlet
- Siphon, faucet set, movable mix-spout & soap dispenser are available as option

Item No.	mm
KWMS01	380x310x(H)200



Wall Mounted Wash Basin

- Knee operated water outlet
- Siphon, faucet set, movable mix-spout & soap dispenser are available as option

Item No.	mm
KWMS02	400x335x(H)595



Knee-operated hand wash basin

Wall mounting

Stainless steel, Basin Ø 350 mm
Time-controlled mechanical interval - approx. 15 sec.
(depending on water pressure), knee operated
Optional cold and/or hot water connection
Size: W 400 x D 400 x H 345/510 mm
Height including tap 510 mm
Including swivelling tap 200 mm and syphon Ø 40 mm
Code-No.: HWB-01

Hand wash basin / Sink combination

Stainless steel
Handwash basin: W 370 x D 280 x H 120 mm
Sink: W 405 x D 340 x H 170 mm
With 1 mixing faucet 1/2", syphon and folding grid
Size: W 510 x D 700 x H 850 mm
Code-No.: HWB-02



Wash Basin Mixer



Code No.: HY3301

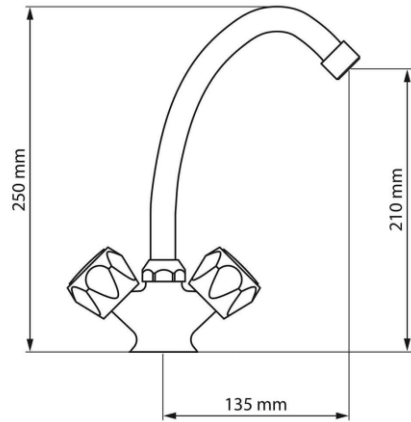

Code No.: HY3302

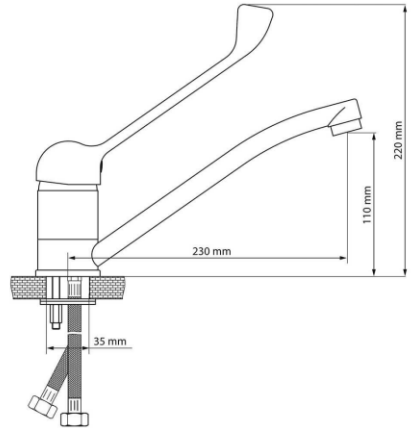

Code No.: HY3303

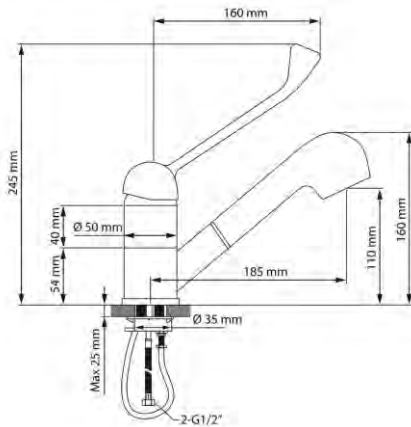

Pre-rinse spray with tap



Code No.: HY3304



Code No.: HY3305



Code No.: HY3306

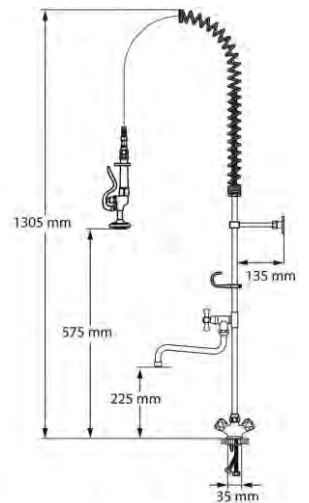
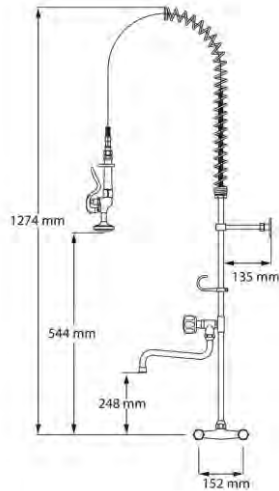
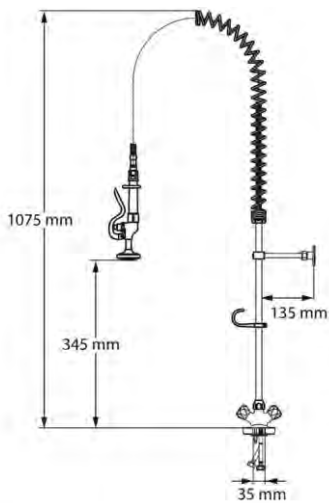

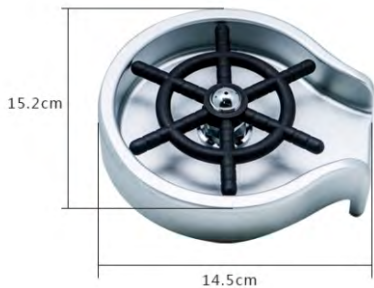

Glass rinser

Size: W 152 x D 145 x H 30mm

Material: Aluminium

Code-No.: HY3308A



GN Pan Basin

Code	Size(mm)
GN11100-B	GN1/1x100mm
GN11150-B	GN1/1x150mm
GN12150-B	GN1/2x150mm
GN13150-B	GN1/3x150mm
GN23100-B	GN2/3x100mm
GN23150-B	GN2/3x150mm



Glass rinser GN 1/6

Size: W 175 x D 165 x H 68mm

Code-No.: HY3308



Glass rinser GN 1/4

Size: W 265 x D 162 x H 68mm

Code-No.: HY3307



Glass rinser

Size: W 420 x D 230 x H 30 mm

Code-No.: HY3309A



Glass rinser

Size: W 650 x D 220 x H 30 mm

Code-No.: HY3309



Paper Towel Dispenser

Size: W 280 x D 100 x H 390 mm
Code-No.: PTD-05



Jumbo Toilet Tissue Dispenser

Size: W 260 x D 260 x H 120 mm
Code-No.: PTD-02



Paper Towel Dispenser

Hand Dryer
Waste Receptacle
3pcs in 1

Size: W 320 x D 160 x H 1650 mm

Code-No.: PTD-06

Voltage: 220V~240V / 50Hz
Rated Power: 2500W
Current: 10.9A
Air Volume: 270 m³/h
Air Velocity: 30 m/s



Paper Towel Dispenser

Size: W 125 x D 125 x H 125 mm
Code-No.: PTD-03



Seat Cover Dispenser

Size: W 400 x D 50 x H 300 mm
Code-No.: PTD-04



Paper Towel Dispenser

Size: W 280 x D 102 x H 370 mm

Code-No.: PTD-01



Electronic Sterilization Knife Box

Size: W 510 x D 125 x H 620 mm
one door

Code-No.: EKB-01

Size: W 1020 x D 125 x H 620 mm
double doors

Code-No.: EKB-02



Electric mosquito killers

2 UV tubes 20W, cover 10-25 m³

Size: 373x350x55 mm

Code-No.: HY3312

2 UV tubes 30W, cover 25-40 m³

Size: 480x250x55 mm

Code-No.: HY3313

2 UV tubes 30W, cover 35-60 m³

Size: 630x250x55 mm

Code-No.: HY3314



Soap Dispenser 360ml

Size: W 80 x D 82 x H 190 mm

Code-No.: SD-01



Soap Dispenser 1000ml

Size: W 125 x D 110 x H 205 mm

Code-No.: SD-02



Soap Dispenser 1000ml

Size: W 165 x D 105 x H 295 mm

Code-No.: SD-05



Soap Dispenser 1200ml

Size: W 100 x D 140 x H 210 mm

Code-No.: SD-03



Foam Soap Dispenser 1000ml

Size: W 120 x D 100 x H 223 mm

Code-No.: SD-04



Automatic Hand Dryer

Size: W 270 x D 124 x H 240 mm

Code-No.: **HD-03**

Voltage: 220V-240V~/50Hz 110-120V/60Hz

Rated Power: 2500W 1700W

Current: 10.9A 15.5A



Automatic Hand Dryer

Size: W 270 x D 124 x H 240 mm

Code-No.: **HD-04**

Voltage: 220V-240V~/50Hz 110-120V/60Hz

Rated Power: 2500W 1700W

Current: 10.9A 15.5A



Automatic Hand Dryer

Size: W 270 x D 200 x H 240 mm

Code-No.: **HD-05**

Voltage: 220V-240V~/50Hz 110-120V/60Hz

Rated Power: 2500W 1700W

Current: 10.9A 15.5A



Automatic Hand Dryer

Size: W 270 x D 200 x H 240 mm

Code-No.: **HD-06**

Voltage: 220V-240V~/50Hz 110-120V/60Hz

Rated Power: 2500W 1700W

Current: 10.9A 15.5A



Automatic Hand Dryer

Size: W 280 x D 174 x H 300 mm

Code-No.: **HD-07**

Voltage: 220V-240V~/50Hz 110-120V/60Hz

Rated Power: 900W 900W

Current: 3.9A 8A



Automatic Hand Dryer

Size: W 280 x D 174 x H 300 mm

Code-No.: **HD-08**

Voltage: 220V-240V~/50Hz 110-120V/60Hz

Rated Power: 900W 900W

Current: 3.9A 8A

JET HAND DRYER

Size: W 300 x D 250 x H 680 mm

Code-No.: HD-00

Voltage:	220V-240V~/50Hz	110-120V/60Hz
Rated Power:	1400W	1400W
Current:	8A	13A
Degree of Protection:	IP 22	IP 22
Air volume:	220m ³ /h	220m ³ /h
Air velocity:	110m/s	110m/s
Noise Level:	>78dB	>78dB
Packing Size:	735x371x330mm	28 ⁷ / ₈ "x14 ⁵ / ₈ "x13"
Unit weight:	8.6kg	19lb
CTN QTY.: (1pc)	10.4kg	23 lb
CTNS of 20'FT:	336pcs (336 CTNS)	

- 1.High-speed brushless DC motor that produces 110 m/s jet airflow
- 2.Dry hands in 5-10 seconds
- 3.Controlled by CPU, with LED screen
- 4.Alternative of cool air or warm air
- 5.Hygienic filter bag, antibacterial and harmful gases absorbable
- 6.Unique design, energy-saving, economical and durable



Automatic Hand Dryer

Size: W 245 x D 245 x H 263 mm

Code-No.: HD-01

Voltage:	220V-240V~/50Hz	110-120V/60Hz
Rated Power:	1800W	1500W
Current:	7.8A	13.6A



Automatic Hand Dryer

Size: W 240 x D 208 x H 268 mm

Code-No.: HD-02

Voltage:	220V-240V~/50Hz	110-120V/60Hz
Rated Power:	1800W	1500W
Current:	7.8A	13.6A



Hair Dryer

Size: W 180 x D 91 x H 210 mm

Code-No.: HD-09

Voltage: 220V-240V~/50Hz 110-120V/60Hz

Rated Power: 1200W 1000W

Current: 5.2A 9.1A



Hair Dryer

Size: W 205 x D 112 x H 118 mm

Code-No.: HD-10

Voltage: 220V-240V~/50Hz 110-120V/60Hz

Rated Power: 1200W 1000W

Current: 5.2A 9.1A



Hair Dryer

Size: W 205 x D 110 x H 580 mm

Code-No.: HD-11

Voltage: 220V-240V~/50Hz 110-120V/60Hz

Rated Power: 1500W 1500W

Current: 4.3A 9.1A



Hair Dryer

Size: W 205 x D 110 x H 580 mm

Code-No.: HD-12

Voltage: 220V-240V~/50Hz 110-120V/60Hz

Rated Power: 1500W 1500W

Current: 6.5A 13.6A



Cosmetic Mirror

Size: Dia.190 mm

Code-No.: MR01



Cosmetic Mirror with LED Light

Size: Dia.200 mm

Code-No.: MR02



Medical Box

Size: W 300 x D 300 x H 120 mm

Code-No.: PTD-09



**Medical Box
(other colors available)**

Size: W 300 x D 300 x H 120 mm

Code-No.: PTD-10



Toilet Brush

Size: Dia.100 x H 370 mm

Code-No.: TB01



Pedal Bins

<u>Code-No.</u>	<u>Capacity</u>	<u>Sizes (cm)</u>
M5003L	3L	Dia17 x (H)27
M5005L	5L	Dia20.5 x (H)28.5
M5012L	12L	Dia25 x (H)39.5
M5020L	20L	Dia29 x (H)44.5
M5030L	30L	Dia29.5 x (H)65.5



Shoe Polisher

Size: W 260 x D 240 x H 400 mm

Code-No.: 603 001

- Three quiet rotation brushes
- One cleaning brush for coarse dirt
- Two polishing brushes made of terylene (polyester) for light and dark shoes
- Shoe cream dispenser with ball valve for 100 ml fluid shoes cream (unfilled)



Pedal Bins

<u>Code-No.</u>	<u>Capacity</u>	<u>Sizes (cm)</u>
HY3315	3L	Dia17 x (H)30
HY3316	5L	Dia20 x (H)31
HY3317	7L	Dia20 x (H)37
HY3318	12L	Dia24.5 x (H)45.5
HY3319	20L	Dia29 x (H)49.5
HY3320	30L	Dia29.5 x (H)66



Outdoor Bins

<u>Code-No.</u>	<u>Capacity</u>	<u>Sizes (cm)</u>
HY3321	12L	Dia25 x (H)37
HY3322	15L	Dia25 x (H)43.5
HY3323	18L	Dia25 x (H)51.5
HY3324	25L	Dia25 x (H)60
HY3325	35L	Dia29.5 x (H)66
HY3326	50L	Dia35 x (H)74.5
HY3327	70L	Dia35 x (H)90



Outdoor Bins

<u>Code-No.</u>	<u>Capacity</u>	<u>Sizes (cm)</u>
HY3328	12L	Dia25 x (H)37
HY3329	15L	Dia25 x (H)43.5
HY3330	18L	Dia25 x (H)51.5
HY3331	25L	Dia25 x (H)60
HY3332	27L	Dia25 x (H)68
HY3333	50L	Dia35 x (H)74.5
HY3334	70L	Dia35 x (H)90



Swing Trash Bin

<u>Code-No.</u>	<u>Capacity</u>	<u>Sizes (cm)</u>
HY3335	5L	Dia20.5 x (H)25.5
HY3336	9L	Dia20.5 x (H)28.5
HY3337	15L	Dia25 x (H)30.5
HY3338	25L	Dia25 x (H)48
HY3339	35L	Dia29.5 x (H)51.5
HY3340	40L	Dia29.5 x (H)57.5
HY3341	50L	Dia35 x (H)57.5
HY3342	70L	Dia35 x (H)73.5

Waste Bins

Item No.	mm
HY3343	50L, Dia350x(H)720
HY3344	65L, Dia350x(H)890



Ashtray trash can

Item No.	mm
HY3345	12L, Dia205x(H)580
HY3346	30L, Dia290x(H)610



Ashtray trash can

Item No.	mm
HY3347	300x240x(H)605



Ashtray trash can

Item No.	mm
HY3348	8L, Dia.140 x (H)555



Ashtray trash can

Item No.	mm
HY3349	12L, Dia.205x(H)580
HY3350	30L, Dia.290x(H)610



Trash can

Item No.	mm
HY3356-1	dia.170x(H)285,3L
HY3356-2	dia.250x(H)430,12L
HY3356-3	dia.290x(H)690,30L



Table top bin

Item No.	mm
HY3357	Dia.120 x (H)180





GARBAGE CAN WITH HOLE LID

Item No.	mm
HY3351H	80L, Dia.560 x (H)620
HY3352H	120L, Dia.660 x (H)700



GARBAGE CAN WITH TILTED LID

Item No.	mm
HY3351T	80L, Dia.560 x (H)620
HY3352T	120L, Dia.660 x (H)700



GARBAGE CAN WITH FLAT LID

Item No.	mm
HY3351	80L, Dia.560 x (H)620
HY3352	120L, Dia.660 x (H)700
HY3353	168L, Dia.680 x (H)800



WHEEL BASE

Item No.	mm
HY3354	Base, 4 wheels for 80L
HY3355	Base, 5 wheels for 120L, 168L



Plastic Recycling Waste Bins 58L

Item No.	mm
GX58L-1	330x470x(H)800, Push Lid
GX58L-2	330x470x(H)800, Can & Bottle
GX58L-3	330x470x(H)800, Paper



Dustbin Plastic

Item No.	mm
MGX024	24L, 380x280x(H)510, with Lid
MGX035	35L, 430x295x(H)655, with Lid
MGX024	24L, 380x280x(H)510
MGX035	35L, 430x295x(H)655



Dustbin Plastic

Item No.	mm
MGX12C	12L, 290x210x(H)300
MGX15B	15L, 290x200x(H)310
MGX08B	8L, 230x160x(H)260



Double-deck Trash Bin

Item No.	mm
MGX010	10L, Dia.240x(H)260

PS: Others Leather option

PP Push Cover Waste Bins

Item No.	mm
MGB20L	20L, 340x240x(H)450
MGB40L	40L, 410x275x(H)610
MGB58L	58L, 470x335x(H)770



Pedal Bins Plastic

Item No.	mm
M6045L	45L, 410 x 400 x (H)580
M6065L	65L, 490 x 400 x (H)660
M6087L	87L, 490 x 400 x (H)810



Clean Bucket Plastic

Item No.	mm
CBP-03	295x295x(H)260



Clean Bucket Plastic

Item No.	mm
CBP-01	500x295x(H)340



#MWB-24L

- Made of polypropylene
- Smooth & tough castors
- Warning sign on both sides
- Size: 490 x 280 x (H)700 mm



#MWB-32L

- Made of polypropylene
- Smooth & tough castors
- Warning sign on both sides
- Size: 640 x 390 x (H)890 mm



#CFLS/24CIP

- Made of polypropylene
- Customized printing
- A shape, 610mm/24"
- "CLEANING IN PROGRESS"

Available:
"CAUTION WET FLOOR"
(#CFLS/24WF)



#CFLS/CONE

- Made of polypropylene
- Customized printing
- Cone shape, "NO PARKING"
- Size: 320 x 320 x 1150 mm





Janitorial Cleaning Cart

Item No.	mm
JCC-121	1210x490x(H)990, with Lid
JCC-125	1250x510x(H)950, w/o Lid



Broom & Dustpan Plastic

Item No.	mm
BD-01	Broom, 50x300x(H)1000
BD-02	Dustpan, 300x280x(H)860

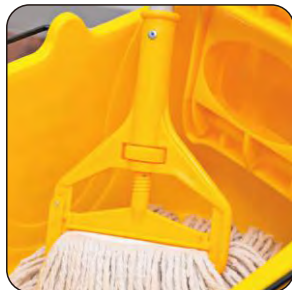

Plastic Side-Release Mop Handle

Item No.	mm
PMH-01	Head size: 300x190, Handle size: 1260

High- Grade Dust Mop

Item No.	mm
PMH-02	Handle, 1340
PMH-03	Head sizes: A - 550x175 B - 650x175 C - 900x175 D - 1250x175 E - 1550x175



Plastic Mop Handle

Item No.	mm
PMH-04	180x(H)1280



Plastic & Aluminum Window Squeegee

Item No.	mm
PMH-05	Handle size: 1340, Head Width: A - 250mm B - 350mm C - 400mm D - 450mm





c a t e r i n g

ELECTRICALS



Coffee Urn

- Made of SS#304
- Stainless steel locking lid
- Non-drip tap
- Thermostat adjustable from 30 ° C to 100 ° C

Single Layer style

<u>Item No.</u>	<u>mm</u>	<u>Power (W)</u>	<u>Capacity (L)</u>	<u>Capacity</u> Cup (160ml)
ECU-68S	Ø 220 x H 395	950W	6,8	48 Cups
ECU-88S	Ø 220 x H 430	950W	8,8	60 Cups
ECU-100S	Ø 220 x H 465	950W	10,0	67 Cups
ECU-150S	Ø 270 x H 465	1650W	15,0	100 Cups
ECU-200S	Ø 270 x H 490	2500W	20,0	120 Cups

Double Wall layer style

<u>Item No.</u>	<u>mm</u>	<u>Power (W)</u>	<u>Capacity (L)</u>	<u>Capacity</u> Cup (160ml)
ECU-68D	Ø 220 x H 395	950W	6,8	48 Cups
ECU-88D	Ø 220 x H 430	950W	8,8	60 Cups
ECU-100D	Ø 220 x H 465	950W	10,0	67 Cups
ECU-150D	Ø 270 x H 465	1650W	15,0	100 Cups
ECU-200D	Ø 270 x H 490	2500W	20,0	120 Cups

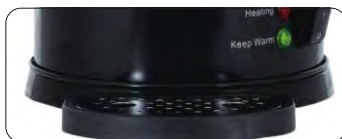

Removable cup rest available

Water Boiler

- Made of SS#304
- Stainless steel locking lid
- Non-drip tap
- Thermostat adjustable from 30 ° C to 100 ° C

Single Layer style

<u>Item No.</u>	<u>mm</u>	<u>Power (W)</u>	<u>Capacity (L)</u>
EWB-68S	Ø 220 x H 395	950W	6,8
EWB-88S	Ø 220 x H 430	950W	8,8
EWB-100S	Ø 220 x H 465	1600W	10,0
EWB-150S	Ø 270 x H 465	1650W	15,0
EWB-200S	Ø 270 x H 490	2500W	20,0
EWB-250S	Ø 270 x H 560	2800W	25,0

Double Wall layer style

<u>Item No.</u>	<u>mm</u>	<u>Power (W)</u>	<u>Capacity (L)</u>
EWB-68D	Ø 220 x H 395	950W	6,8
EWB-88D	Ø 220 x H 430	950W	8,8
EWB-100D	Ø 220 x H 465	1600W	10,0
EWB-150D	Ø 270 x H 465	1650W	15,0
EWB-200D	Ø 270 x H 490	2500W	20,0
EWB-250D	Ø 270 x H 560	2800W	25,0





Water Boiler ECO

- Made of SS#201
- Stainless steel locking lid
- Non-drip tap
- Thermostat adjustable from 30 ° C to 100 ° C

Single Layer style

<u>Item No.</u>	<u>Capacity</u>	<u>Power (W)</u>	<u>Pcs/CTNS</u>	<u>Size (CM)</u>
EW-60S	6L	1800W	4	57*57*44.3
EW-80S	8L	1800W	4	57*57*46.5
EW-100S	10L	1800W	4	57*57*53.7
EW-140S	14L	1800W	2	66*34.5*54.5
EW-160S	16L	1800W	2	67*34*57
EW-200S	20L	1800W	2	67*34*61
EW-250S	25L	2500W	1	41.5*42*47.5
EW-300S	30L	2500W	1	41.5*42*52
EW-350S	35L	2500W	1	41.5*42*56
EW-400S	40L	2500W	1	41.5*42*61



Panini Grill

Item No.: PG-1

- Material: (housing and drip tray) stainless steel, (grill plate) cast iron, (handle) heat-insulating plastic
- Grill plate grooved
- Removable grease collector
- Grill plates are easy to clean
- Temperature range: 50 - 300 ° C
- Dimensions (outside): W 320 x D 410 x H 190 mm
- Dimensions (top grill plate): W 215 x D 215 mm
- Dimensions (grill plate below): W 220 x D 230 mm
- Weight: 16 kg
- Connection: 230 V - 1 Ph. - 1.8 kW

Hot Dog Machine

Item No.: HDW-1

- Stainless steel
- Glass cylinder: Ø 200 mm, height 240 mm
- Adjustable temperature from 30 °C to 100 °C
- Safety thermostat in case of overheating
- Power: 800 W / 230 V
- Dimensions: W 280 x D 280 x H 355 mm
- Weight: 5.9 Kg



Hot Dog Machine, 4 toast sticks

Item No.: HDW-4

- Stainless steel
- Glass cylinder Ø 200 mm, height 240 mm
- 4 heating pads for bread, height 220 mm
- Thermostat adjustable from 40 °C to 100 °C
- Safety thermostat in case of overheating
- Power: 960 W / 230 V
- Dimensions: L 500 x D 285 x H 390 mm
- Weight: 8.7 Kg





Bain Marie

Item No.: BM-160

- For 1/1 or 2 x 1/2 or 3 x 1/3 GN containers
- GN container depth up to 150 mm
- Seamless upper edge
- deep drawn inner container
- Adjustable thermostat and control lamp
- Delivery without GN container
- Dim. inside: T 510 x W 305 x H 160 mm
- Dim. outside: W 540 x W 334 x H 225 mm
- Connection: 230 V / 1 Ph / 1 kW
- Weight: 8 kg gross



Deep Fryer

- Housing, cover, stainless steel control panel
- Thermostat adjustable from 60 ° C to 190 ° C
- Safety thermostat
- Power: 230 V

Single Layer style

Item No.	MM	Tank / Power [KW]
EDF-4L-1	180 x 420 x H 290	1 tank, 2KW
EDF-4L-2	390 x 420 x H 290	2 tanks, 2+2KW
EDF-6L-1	270 x 420 x H 290	1 tank, 3KW
EDF-6L-2	560 x 420 x H 290	2 tanks, 3+3KW
EDF-8L-1	270 x 420 x H 340	1 tank, 3KW
EDF-8L-2	560 x 420 x H 340	2 tanks, 3+3KW



Electric Chrome Griddle

Item No.: EDG-1

- Stainless steel housing
- Hard chromed fry top
- Spatter protection
- Removable drip tray
- Safety thermostat
- Temperature: up to +300 ° C
- Size: W 720 x W 460 x H 240 mm
- Fry top: 518 x 328 mm, full smooth
- Connection: 230 V / 1 Ph / 1.75+1.75 kW
- Weight: 38 kg gross

Electric Salamander

Item No.: ES-1

- Material: (housing) stainless steel
(grill) chromed steel
(handle) heat-insulating plastic
- 3 pairs of U-rails for inserting the grill grate
- Including 1 grill
- Extractable crumb tray
- Timer: 30 minutes
- Temperature range: 50 - 300 ° C
- Dimensions (grill): W 460 x D 255 mm
- Dimensions (outside): W 610 x D 325 x H 280 mm
- Weight: 14 kg
- Connection: 230 V - 1 Ph. - 2.5 kW



Crepe Maker

Item No.: ECM-1

- Material: (housing) stainless steel, (plate) cast iron
- 1 plate
- Including dough distributor
- Easy and quick cleaning
- Temperature range: 50 - 300 ° C
- Dimensions (outside): W 450 x D 490 x H 235 mm
- Plate: Ø 400 mm
- Weight: 14 kg
- Connection: 230 V - 1 Ph. - 3 kW



Plate Warmer

Item No.: PM-60

- Material: stainless steel
- 3 shelves on rails, for pulling out
- Manual temperature setting
- Allows heating of 60 plates at the same time
- For plates with max. 28 cm diameter
- 4 wheels with parking brake
- Fan ensures even heat distribution
- delivery without plate
- Temperature range: 35 - 85 ° C
- Content: 70 L
- Dimensions (inside): 3 x W 290 x D 430 x H 110 mm
- Dimensions (outside): W 600 x D 530 x H 770 mm
- Weight: 14 kg
- Connection: 230 V - 1 Ph. - 0.6 KW





c a t e r i n g

CAFE & BAR





Free flow pourer

- plastic, 75x30mm

code	color	pack (pcs)
BR5521B	blue	12
BR5521Y	yellow	12
BR5521O	orange	12
BR5521K	black	12
BR5521G	green	12



Free flow pourer

- plastic

code	color	pack (pcs)
BR5515	blue	12
BR5515	red	12
BR5515	white	12
BR5515	yellow	12



Ball measuring pourer

BR5527	2.0cl , 3.8x9.7cm
BR5528	3.5cl , 3.8x9.7cm
BR5529	5.0cl , 3.8x9.7cm



Free flow pourer

- stainless steel

code	detail
BR5515	slow flow
BR5515	with flip top
BR5515	fast flow



Eco flow pourer plastic

- plastic

code	mm
BR5520	85x32



Wine vacuum stopper

- EVA

code	mm
BR5530	Dia 3.35 x H4.7



Free flow pourer

code	color
BR5525	style A
BR5526	style B



Champagne bottle cup

code	mm
BR5514	dia.40x55



NON-DRIP POURER

code	capacity
BR5516	25ml
BR5517	30ml
BR5518	45ml



Standard support for bottle

- Aluminium

code	mm
BR5531	310
BR5531B	310mm, w/clamp
BR5532	390
BR5532B	390mm, w/clamp



Lemon squeezer

code	mm
BR5547	90x70



Citrus squeezer

code	mm
BR5545	Dia 120 xH 100 mm 0.35L

CITRUS SQUEEZERS

Aluminium alloy with powder coating.

- 592045 green (for limes) 203x60x(H)40
- 592052 yellow (for lemons) 223x75x(H)45
- 592069 orange (for oranges) 232x91x(H)60



CITRUS SQUEEZERS

stainless steel 304

- 592045 Dia.78x215mm



Boston shaker with glass

- BR5502 Dia.90 x 290 mm
0.9L



Shaker ECO

- BR5504 0.35L
- BR5505 0.50L
- BR5506 0.70L



Cocktail shaker

- BR5507 Dia.95 x 250mm



Ice tong

- BR5513 180mm



Cocktail shaker

- BR5507 Dia.95 x 250mm



Double sided measuring cup

- BR5522 20/30 ml
- BR5523 20/40 ml
- BR5524 25/50 ml



Measuring cup

- BR5540 100ml



Measuring cup

- BR5541 250ml



Cocktail strainer

BR5509 W95x200 mm



Eco cocktail strainer

BR5510 W115xH145mm



Julep Cocktail Strainer

BR5511 D162*D75*H19mm



Waiter`s opener

BR5550 110mm



Eco bottle opener

BR5548 127mm



Waiter`s opener

BR5551 120mm



Bottle opener

BR5548 180 mm



Waiter's corkscrew

BR5552 140mm



Beaters

BR5542 210mm

BR5543 210mm



Corkscrew

BR5553 170mm



Beer skimmer

BR5556 230x35mm



Ice tong

BR5513 180mm



Cocktail muddler

BR5544 Dia40xH220mm



Ice bucket with lid

BR5575 2L, dia 150xH160mm
BR5576 3L, dia 170xH190mm
BR5577 5L, dia200xH220mm



Bar dispenser 1L

BR5571 dia 98 x 330mm
(Red, Yellow,Blue,
Green, Orange,
Primary colour)



Ice bucket with lid

BR5578 dia150xH160mm
1.5L



Wall mounted wine rack

BR5537 145x105xH450



Wire shelf rack for glasses

BR5533 2 rails,150/210 x D350 x H55mm
BR5534 3 rails,255/315 x D350 x H55mm
BR5535 4 rails,350/415 x D350 x H55mm
BR5536 5 rails,450/480 x D350 x H55mm

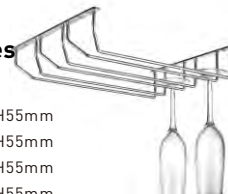

Champagne cooler

BR5566 ø350xH230, 9.5L



Cooler acrylic 4L

BR5567 265x200xH200mm



Salt and sugar glass rimmers

BR5562 200x160xH70 mm



Bar mat

BR5538 450x300xH10mm

BR5539 590x80xH16mm



Bar organizer

BR5558 240x150x105 mm



Condiment Holders 5 boxes

BR5557 500x160x90 mm



Multi racks 3 x1 L

BR5563 240x190xH410mm



Condiment Holder

BR5559 295x148x(H)85, 4 cups

BR5560 375x140x(H)90, 5 cups

BR5561 445x148x(H)85, 6 cups

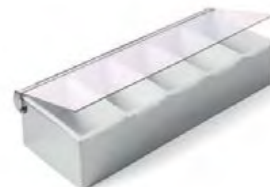

Ice bucket double wall

BR5574 120x195mm



Insulating container for wine

BR5579 dia100/dia120 x H 230 mm



Champagne bucket 4,5L

BR5564 Dia 190xH220mm



Champagne bucket 4,5L

BR5565 Dia 210xH205mm



Transparent Ashtray

BR5572 dia 105x H35 mm



Wine cooler table bracket

BR5570 Dia.195x(H)510mm



Champagne bucket stand

BR5569 Dia 190 x H610 mm
Support pillar: dia 38 mm



Chrome Plated Champagne Stand

BR5568 22xH75cm



Cocktail spoon

BR5508 285mm



GLASS BRUSH ROUND

552681 ø150x(H)190mm



Dessert spoon

BR5512 210mm



GLASS BRUSH STANDARD

696002 190x100x(H)180mm



Wall mounted bottle container

BR5573 540x105xH100 mm

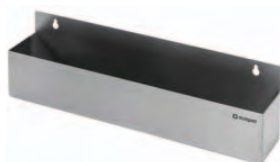

GLASS BRUSH HIGH

696040 190x100x(H)250mm



Ice Bucket PP

CICB01 210x160xH220mm,4.5L
CICB02 245x165xH220mm,5.0L



Ice Bucket PP

CICB03 190x100xH250mm,3L



Ice Bucket PS

CICB04 340x210xH245mm,8L
CICB05 260x160xH200mm,3L



Ice Bucket PP

CICB06 365x265xH195mm
2 dozen beers



Ice Bucket Acrylic

CICB07 125 x 90 x 135mm



Ice Bucket Acrylic

CICB08 120 x 100 x 110mm



Ice Bucket Acrylic

CICB09 120 x 135mm



Service Trays

FT03 Dia.325 x H35mm



Service Trays

FT01 Dia.470 x H23mm
FT02 Dia.345 x H23mm



Service Trays

FT01 Dia.470 x H23mm
FT02 Dia.345 x H23mm

Cup

ST28PR 830 x H90mm



Pitcher

PKL01 Dia. 120 x 350mm, 1.8L
PKL02 Dia. 117 x 200mm, 1.4L
PKL03 Dia. 105 x 171mm, 0.95



Stackable Tumblers

ST54 Dia. 57 x 92mm, 5oz
ST55 Dia. 67 x 101mm, 8oz
ST56 Dia. 70 x 110mm, 10oz
ST57 Dia. 74 x 130mm, 12oz
ST58 Dia. 80 x 145mm, 16oz
ST59 Dia. 85 x 164mm, 20oz
ST60 Dia. 100 x 185mm, 32oz



Fast Food Baskets

FB61 235 x 150 x H46mm
brown, green, red
yellow, black



Fast Food Baskets

FB61 275 x 175 x H38mm
brown, green, red
yellow, black



Milk shaker 1 liter

BR5580 170x170x(H)520 mm
BR5580 170x170x(H)520 mm

Double coffee pressing

BR5612 51/53mm



Round mat

BR5611 Dia.81x15mm



Coffee Tamper

BR5597 Ø49mm
BR5598 Ø51mm
BR5599 Ø58mm



Coffee Tamper

BR5600 Ø49mm
BR5601 Ø51mm
BR5602 Ø58mm



Coffee scoop

BR5605 5ml
BR5606 15ml
BR5607 30ml



Coffee brush

BR5608 Wood +bristle



Clean brush

BR5594 225mm, with spoon



Clean brush

BR5595 225mm, without spoon



Coffee tamper mat

Br5592 L150xH45mm



Coffee Knock Box

BR5609 350x250xH90mm
BR5610 380x255xH100mm



Coffee tamper mat

Br5591 L230xH45mm



Coffee tamper mat

Br5613 142x92xH60mm



Coffee Grind Knock Box

BR5603 170x170x175mm, SS201
BR5604 170x170x175mm, SS304



Temperature with tong

BR5596 0-100 °C



Cup storage stand

BR5590 400x240xH235mm



Cup storage stand

BR5589 415x210xH210mm

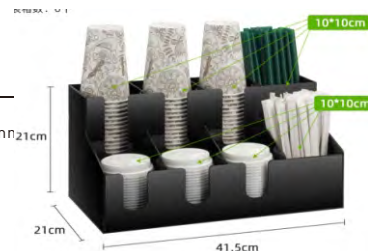



c a t e r i n g

WIREWARE



Fryer Basket

- Wire fry basket with plastic handle
- Made of Chromed plated or SS#304
- This basket have a reinforced base
- 1.2 mm wire mesh with a heavy duty frame
- Comes with rectangular shape

<u>Item No.</u>	<u>MM</u>	<u>Material</u>
FB001	245 x 195 x H 136	Chromed
FB002	245 x 195 x H 136	SS#304
FB003	280 x 140 x H 100	Chromed
FB004	280 x 140 x H 100	SS#304
FB005	308 x 160 x H 135	Chromed
FB006	308 x 160 x H 135	SS#304
FB007	328 x 165 x H 150	Chromed
FB008	328 x 165 x H 150	SS#304
FB009	335 x 165 x H 152	Chromed
FB010	335 x 165 x H 152	SS#304
FB011	337 x 143 x H 143	Chromed
FB012	337 x 143 x H 143	SS#304



OEM Service is available.





Mini Fryer Basket

<u>Item No.</u>	<u>MM</u>	<u>Material</u>
MFB-01	100 x 100 x H 60	SS#304



Mini Fryer Basket

<u>Item No.</u>	<u>MM</u>	<u>Material</u>
MFB-02	105 x 85 x H 65	SS#304

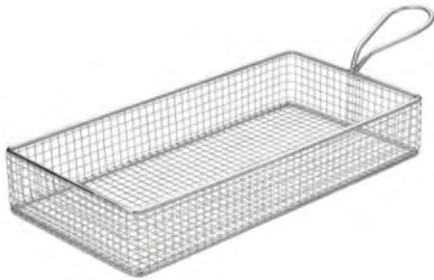

Fryer Basket

<u>Item No.</u>	<u>MM</u>	<u>Material</u>
MFB-03	210 x 100 x H 60	SS#304
MFB-04	260 x 130 x H 45	SS#304



Chip Shovel

<u>Item No.</u>	<u>MM</u>	<u>Material</u>
MFB-05	215 x 215 x H 450	SS#201
MFB-06	215 x 215 x H 450	SS#201



Skimmer Mesh

<u>Item No.</u>	<u>MM</u>	<u>Material</u>
MFB-07	Dia.200 x L 470	SS#201



Flat Skimmer

<u>Item No.</u>	<u>MM</u>	<u>Material</u>
MFB-08	Dia.250 x 500	SS#201

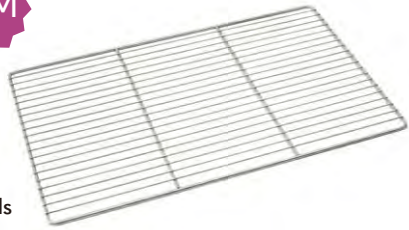

Grids

<u>Item No.</u>	<u>MM</u>	<u>Material</u>
GR11	530 x 325	
GR12	325 x 265	Chrome-plated
GR23	325 x 354	SS#201
GR21	530 x 650	SS#304
GR46	400 x 600	



Tea & Herb Strainer

<u>Item No.</u>	<u>MM</u>	<u>Material</u>
TW7781	dia 75 , 220*75*25	SS#304



Tea Strainer - With Hinged Handle

<u>Item No.</u>	<u>MM</u>	<u>Material</u>
TW7780	dia 50x175	SS#304



French fries shovel

<u>Item No.</u>	<u>MM</u>	<u>Material</u>
KU6622	160 x 420	SS#201



Skimmer Mesh

<u>Item No.</u>	<u>MM</u>	<u>Material</u>
KU6614	5.5 inch/ dia 16 cm	SS#201
KU6615	6 inch/ dia 18 cm	
KU6616	6.5 inch/ dia 22 cm	
KU6617	7 inch/ dia 24 cm	



Flat Skimmer

<u>Item No.</u>	<u>MM</u>	<u>Material</u>
KU6618	dia 16 cm	SS#201
KU6619	dia 20 cm	
KU6620	dia 24 cm	



Single Layer Strainer

<u>Item No.</u>	<u>MM</u>	<u>Material</u>
SLS-01	Dia.75	SS#304
SLS-02	Dia.105	SS#304
SLS-03	Dia.125	SS#304
SLS-04	Dia.130	SS#304
SLS-05	Dia.150	SS#304
SLS-06	Dia.160	SS#304
SLS-07	Dia.180	SS#304
SLS-08	Dia.200	SS#304
SLS-09	Dia.250	SS#304

Double Layer Strainer

<u>Item No.</u>	<u>MM</u>	<u>Material</u>
DLS-01	Dia.75	SS#304
DLS-02	Dia.105	SS#304
DLS-03	Dia.125	SS#304
DLS-04	Dia.130	SS#304
DLS-05	Dia.150	SS#304
DLS-06	Dia.160	SS#304
DLS-07	Dia.180	SS#304
DLS-08	Dia.200	SS#304

OEM SERVICE IS AVAILABLE



Distributed by: